

PLL2215UW - 90° FWHM for High-Bay Applications

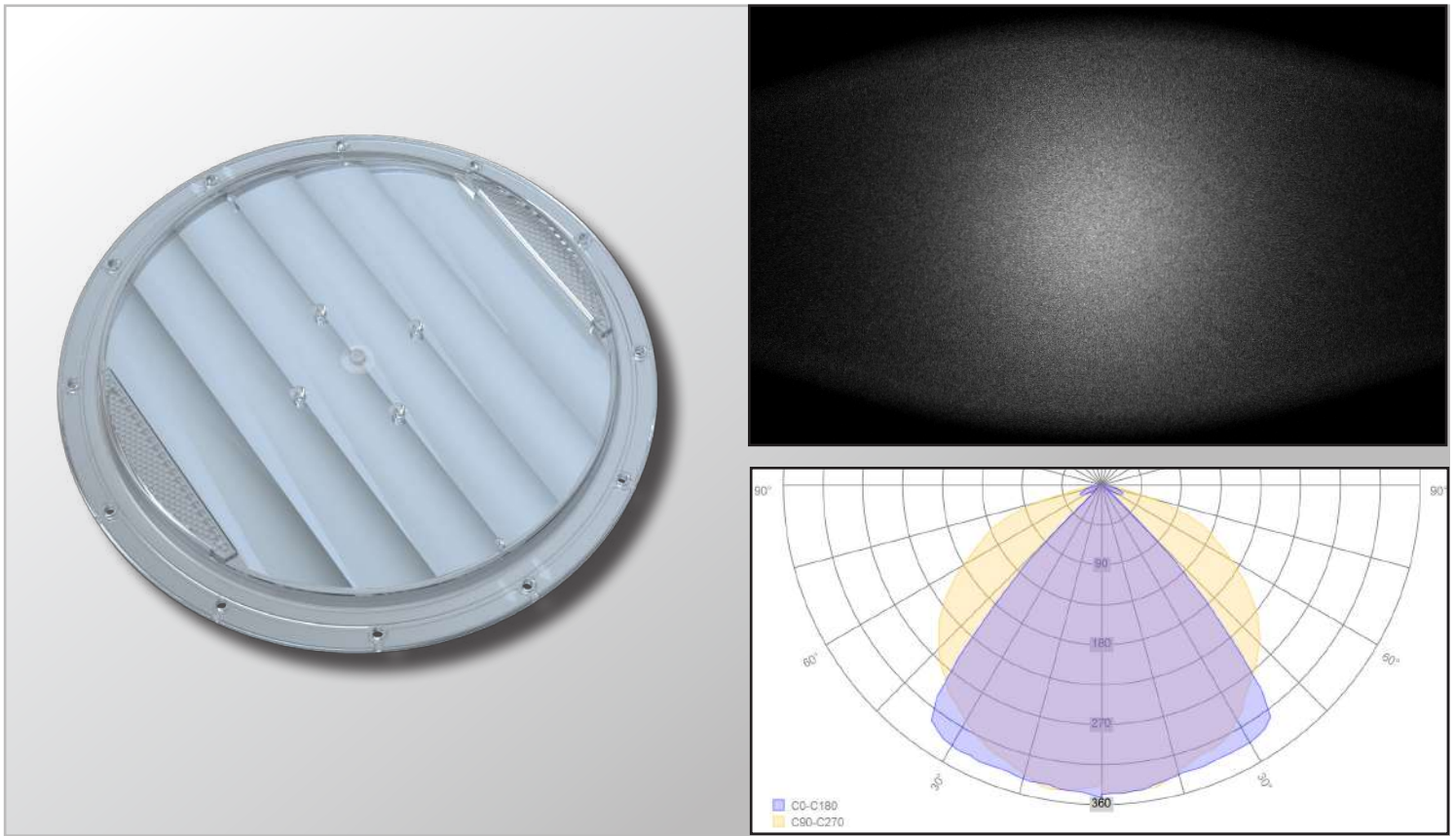

Dimensions	Type of fixing	Material	Beams	LED
300.00mm diameter - 22.60mm height	Screw Fixing: [~ 0.8/1.2 Nm] for M4 screws	PC 5.0 Clear, Non-yellowing, (UL 94V0 on Request)	<ul style="list-style-type: none"> Full angle C0-C180 at 50% from maximum: ~ 85°x120° Full angle C0-C180 at 10% from maximum: ~ 95°x155° 	54 LEDs 5x5mm size, and ~15897Lumen@ ~ 200Watt

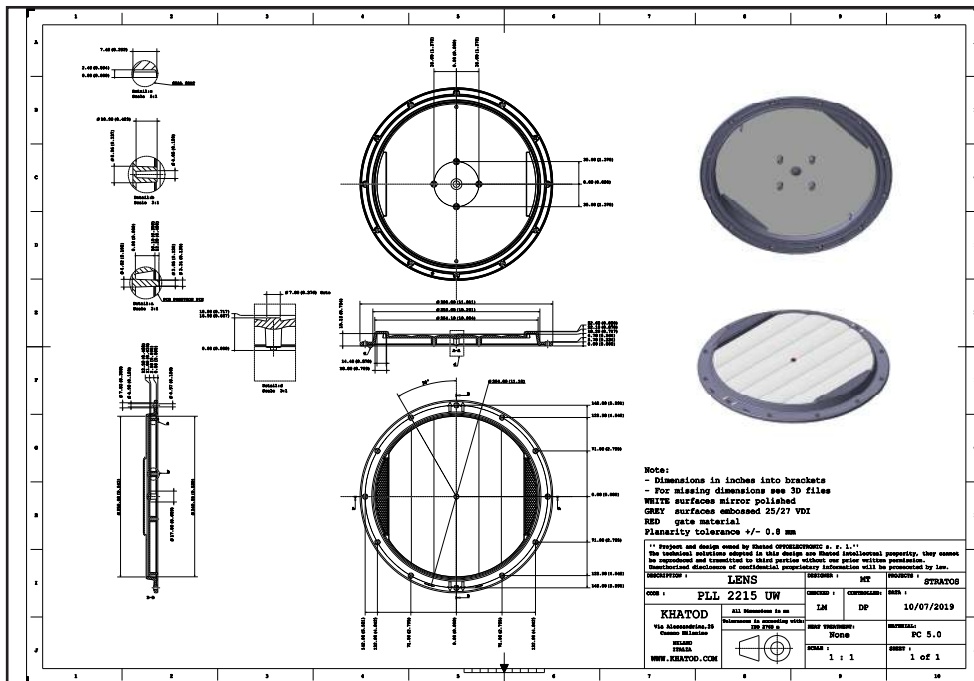

PC 5.0 - Specifications

Property	Test Condition	Unit	Standard	Typical Value**
Rheological Properties				
Melt volume-flow rate (MVR)	300 °C / 1.2 kg	cm ³ /10 min	ISO 1133	34
Molding shrinkage, parallel	60x60x2; 500 bar	%	b.o. ISO 2577	0,65
Molding shrinkage, normal	60x60x2; 500 bar	%	b.o. ISO 2577	
Mechanical properties (23 °C, 50 % r. F.)				
Tensile modulus	1 mm/min	MPa	ISO 527-1,-2	2350
Yield stress	50 mm/min	MPa	ISO 527-1,-2	63
Yield strain	50 mm/min	%	ISO 527-1,-2	6
Nominal strain at break	50 mm/min	%	ISO 527-1,-2	>50
Stress at break	50 mm/min	MPa	ISO 527-1,-2	60
Strain at break	50 mm/min	%	ISO 527-1,-2	125
Flexural modulus	2 mm/min	MPa	ISO 178	2350
Flexural strength	2 mm/min	MPa	ISO 178	97
Flexural strain at flexural strength	2 mm/min	%	ISO 178	7,1
Flexural stress at 3.5 % strain	2 mm/min	MPa	ISO 178	73
Izod notched impact strength	23 °C; 3 mm	kJ/m ²	ISO 7391	55
Izod notched impact strength	-30 °C; 3 mm	kJ/m ²	ISO 7391	12
Thermal properties				
Temperature of deflection under load	1.80 MPa	°C	ISO 75-1,-2	123
Temperature of deflection under load	0.45 MPa	°C	ISO 75-1,-2	136
Vicat softening temperature	50 N; 50 °C/h	°C	ISO 306	143
Vicat softening temperature	50 N; 120 °C/h	°C	ISO 306	145
Coefficient of linear thermal exp., parallel	23-55 °C	10 ⁻⁴ /K	ISO 11359-1,-2	0,65
Coefficient of linear thermal exp., transverse	23-55 °C	10 ⁻⁴ /K	ISO 11359-1,-2	0,65
Oxygen index	Method A	%	ISO 4589-2	28
Glow wire test (GWFI)	1,0 mm	°C	EC 60695-2-12	850
Glow wire test (GWIT)	0,75 mm	°C	EC 60695-2-13	875
Optical Properties				
Luminous transmittance (clear transparent materials)	2 mm	%	ISO 13468-2	90
Luminous transmittance (clear transparent materials)	4 mm	%	ISO 13468-2	>89
Other properties (23 °C)				
Density	-	kg/m ³	ISO 1183	1,19
Material specific properties				
Refractive index	Procedure A		ISO 489	1,584
Haze for transparent materials	3mm		ISO 14782	<0,5
Processing conditions				
Injection molding mold temperature		°C		80
Injection molding melt temperature		°C		280
Injection speed		mm/s		200

Disclaimer

Weatherability / UV resistance

ISO 4892-2A Cycle 1

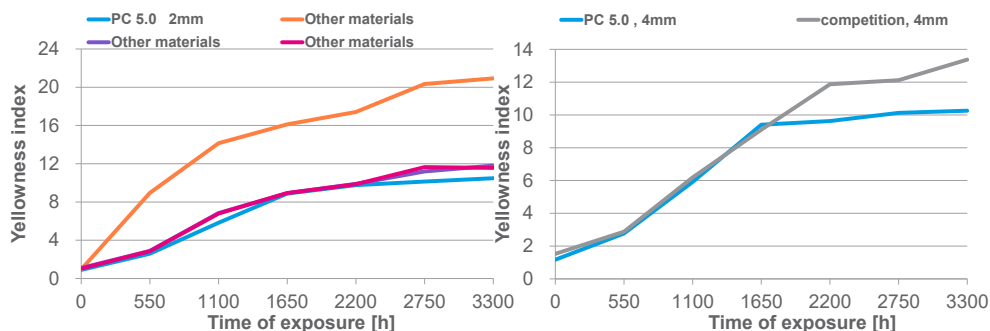

3300 h ~ 2 years Florida ~ 4 years Europe (directly facing the sunlight)

Application Examples

Warehouse application using the 90° beam lens, simulated with

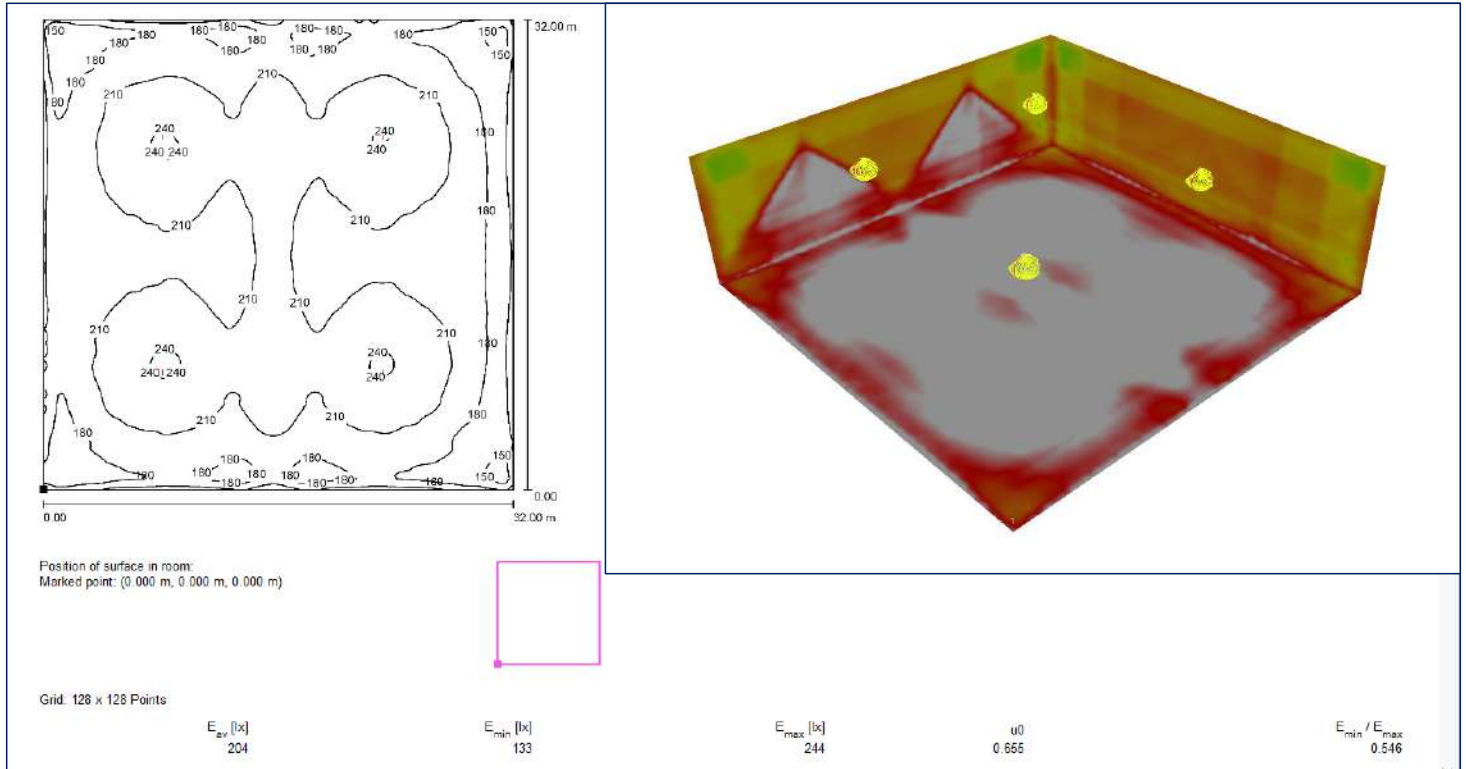

Application Examples

High-shelving application using the elliptical beam lens, simulated with Dialux:

- Shelves height = 8m
- Hallway width = 3m
- Luminaire height = 10m
- Luminaire distance = 15m
- LEDs total flux = 31000lm

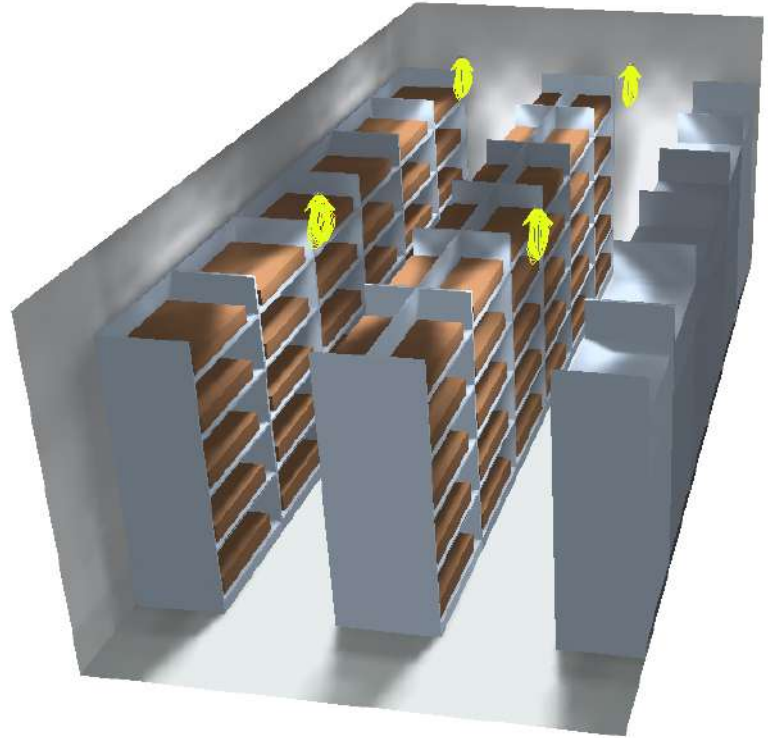

Isolines (lux):

- Image on the right: illuminance distribution between the shelf units.
- Image below: detail of the area between two lighting fixtures. Average, minimum and maximum values are indicated.

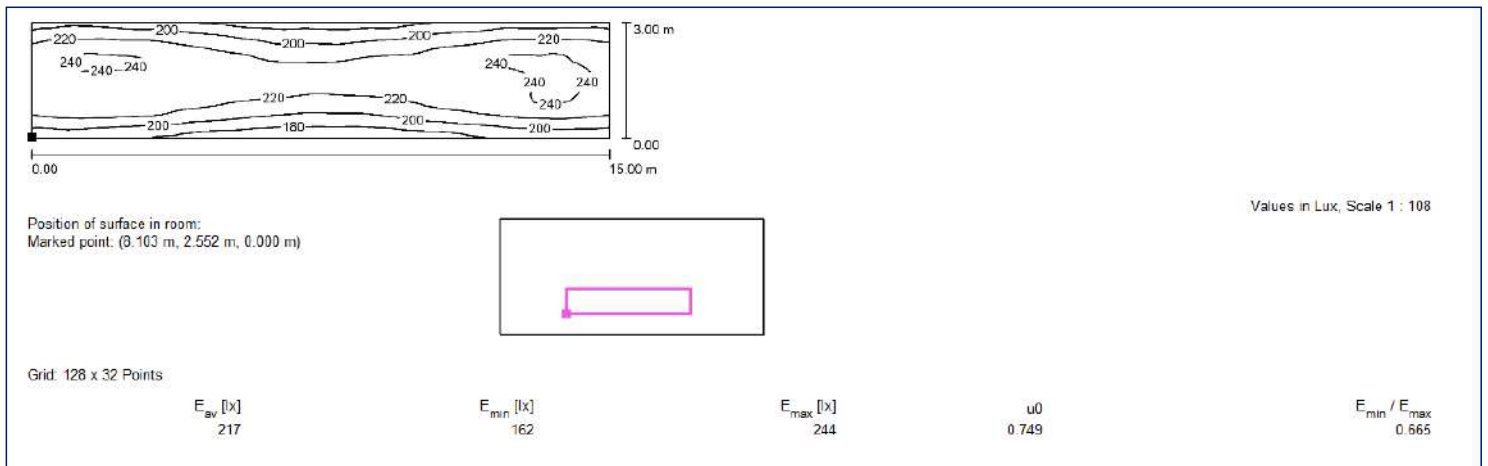
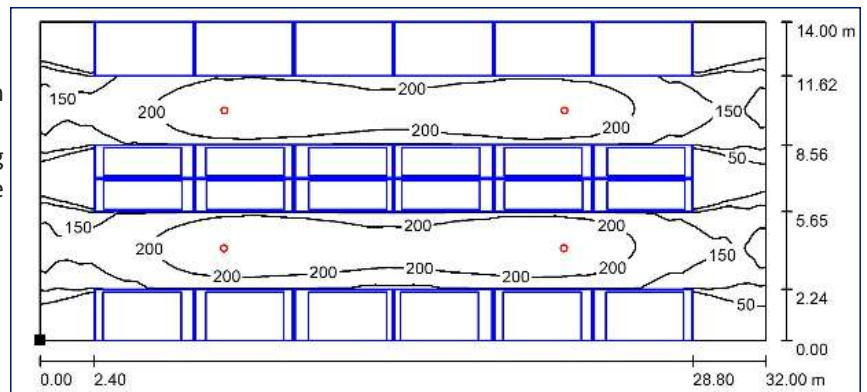

Light Distribution of the Beam Angles

Comparison of the illuminance distribution of STRATOS beam angles - Elliptical, 60°, 90° - using the same application examples and luminaire configurations.

Illuminance distribution on the floor:

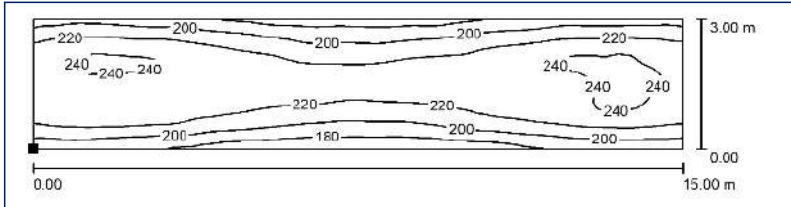

STRATOS EL

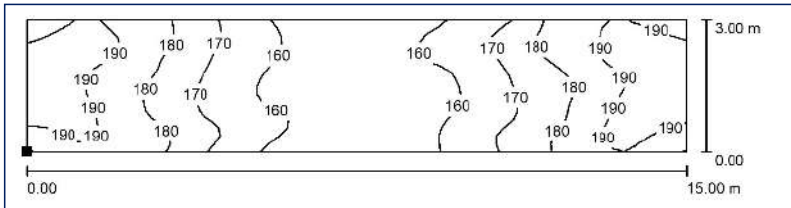

STRATOS 60°

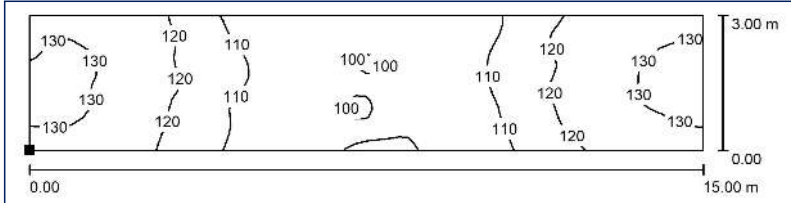

STRATOS 90°

Nominal flux = 31000 lm	Eav [lx]	Emin [lx]	Emax [lx]	U0	Emin/Emax
Stratos EL	217	162	244	0.749	0.665
Stratos 60°	174	151	199	0.870	0.761
Stratos 90°	116	99	133	0.855	0.746

Illuminance distribution in the area in front of the shelves:

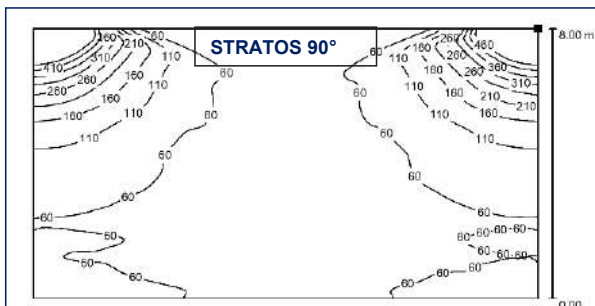
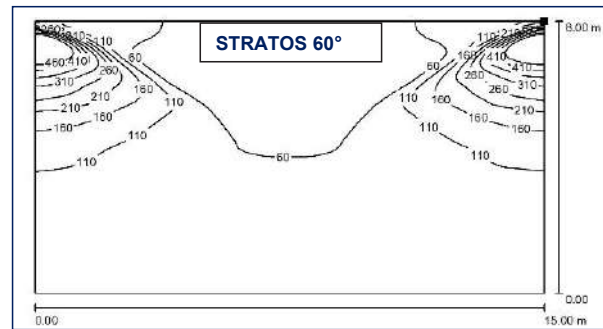
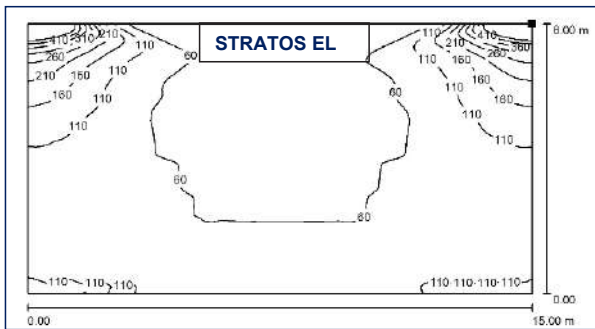

Nominal flux = 31000 lm	Eav [lx]	Emin [lx]	Emax [lx]	U0	Emin/Emax
Stratos EL	91	27	835	0.299	0.033
Stratos 60°	99	20	606	0.198	0.032
Stratos 90°	97	21	1019	0.219	0.021

Silicone Gasket



Silicone Gasket already applied, IPX5

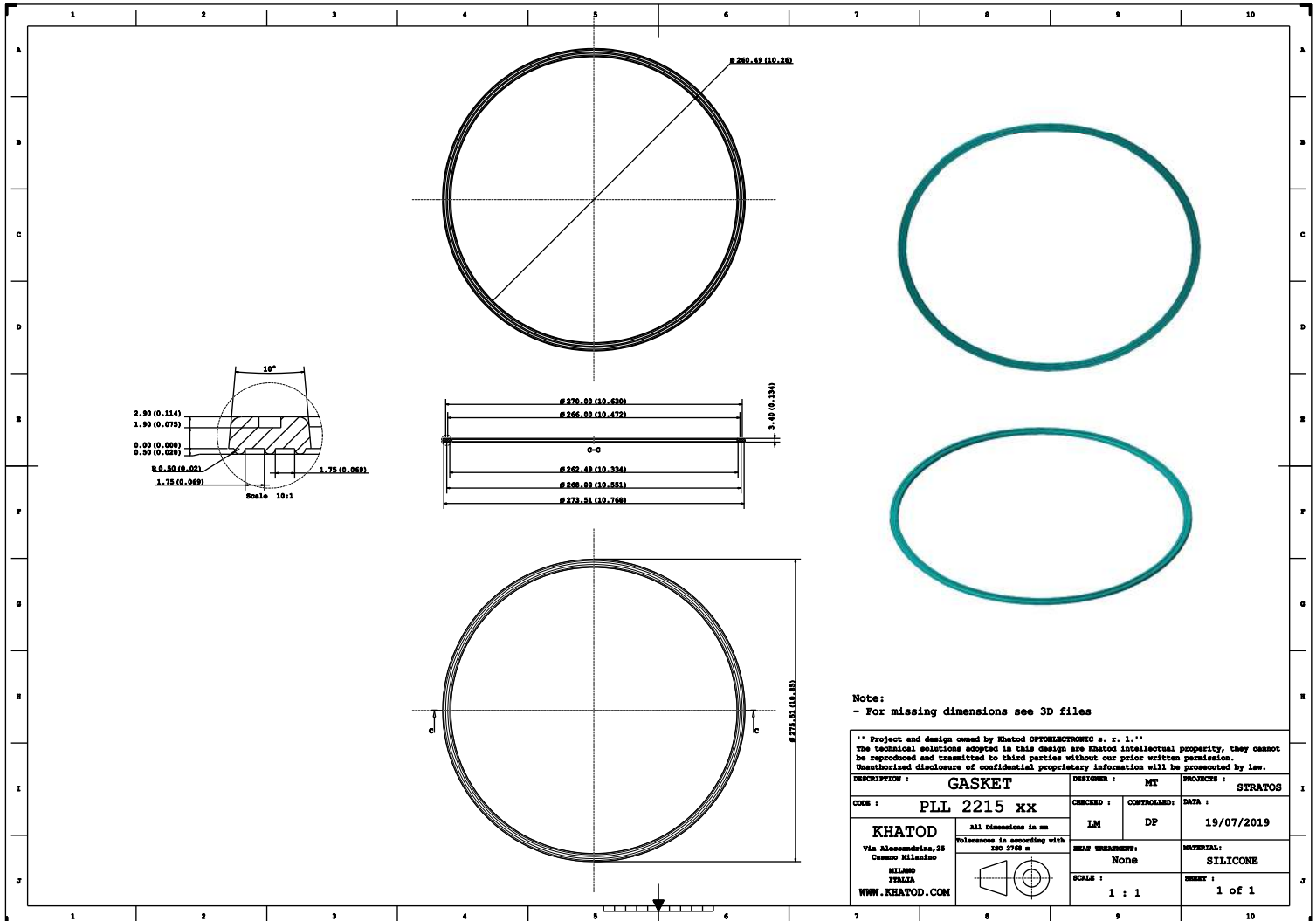

KFP44 - PCB for Testing

To make Stratos lenses testing easier for the customers, Khatod has created a ready-to-use PCB: KFP44.
PCB diagrams and photos are shown below.

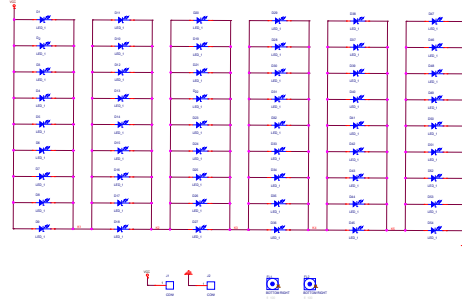
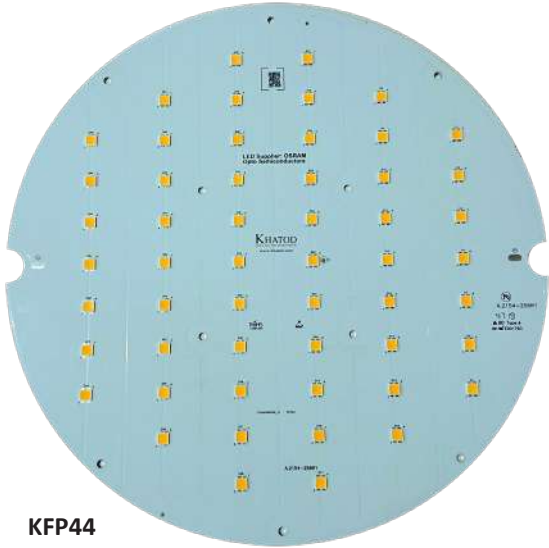

Example using 54 Osram S8 GW P9LMS2.EM-NSNU-50 LEDs
~ 200Watt
~ 16.000 Lumen

The PCB can hold a variable number of LEDs, provided the overall power output is within 50W to 200W.
You can use LEDs of different type, colors and packages
- 2835, 3030, 3535, 5050, 7070 -

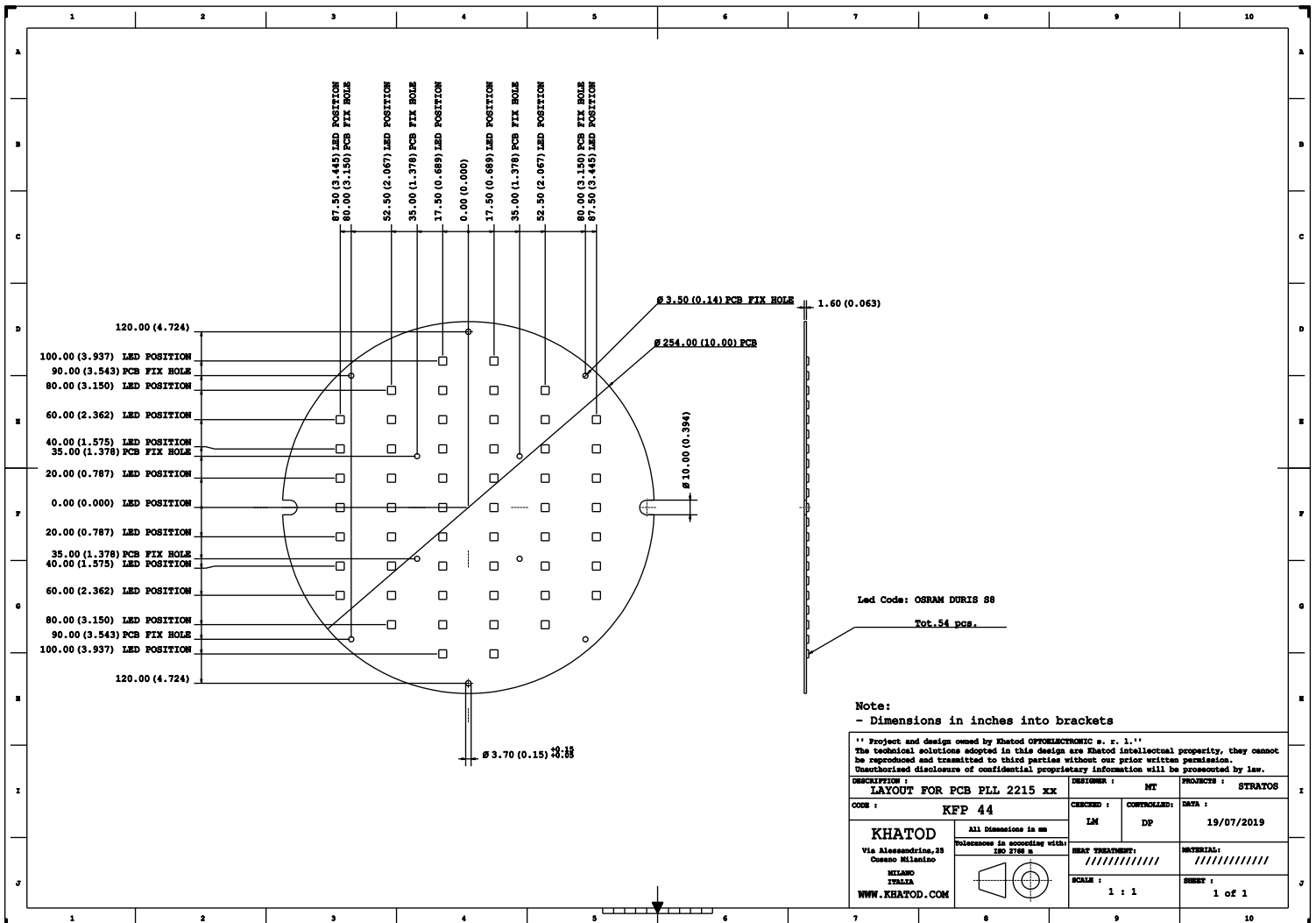

Assembly Specifications

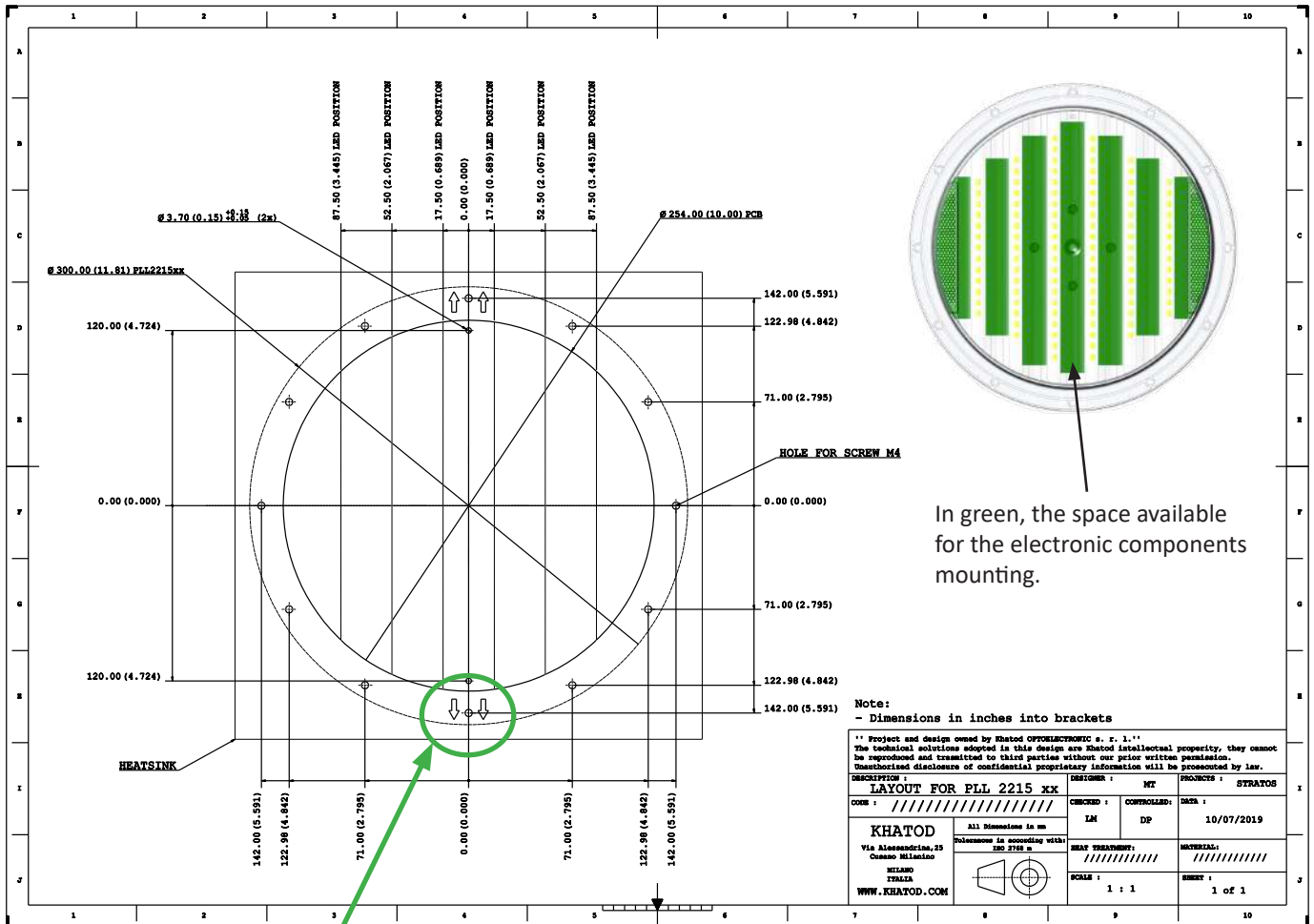

In green, the space available for the electronic components mounting.

The LED rows on the PCB must follow the direction indicated by the arrow marks on the lens.

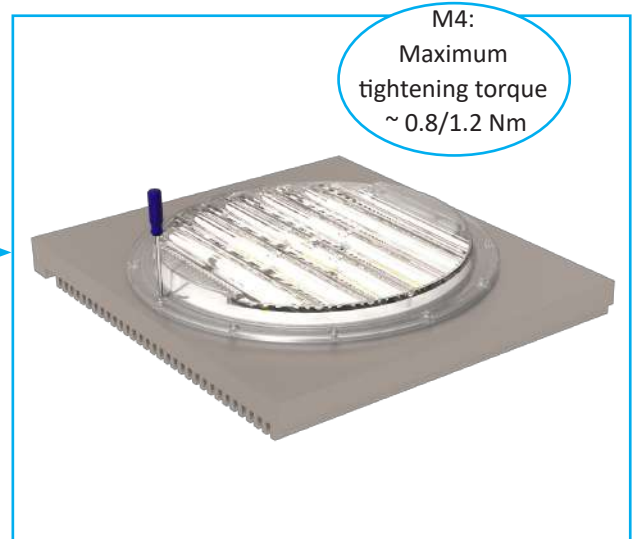
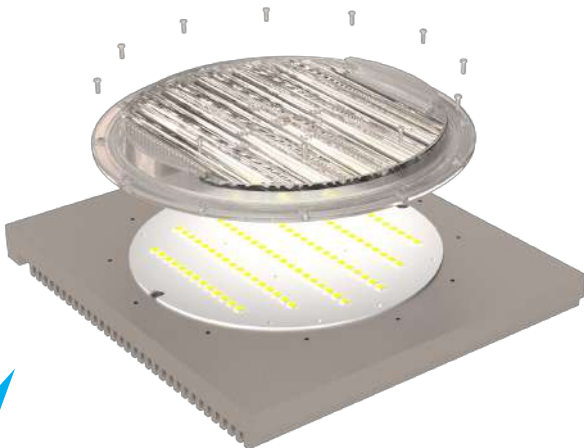

IK Test - Determination of Mechanical Impact Resistance Degree

Note

The present document is an internal document showing the tests carried out by Khatod in its laboratory. The tests, photos and videos presented in this document are made available for demonstration purposes only. Khatod, with its laboratory, is not a certification body. If customers need IK accredited certifications, they have to apply to the appointed Certification Bodies, under their sole care and responsibility.

Initial Visual Inspection

- Before starting with testing, a visual inspection was performed in order to check the integrity of the part under test. The part resulted physically intact.

Tests Execution

Tests were carried out on the part under test according to IK10 (20 Joule)
Test parameters are as follows:

- Impact energy: 20 Joule
- Impacting element: 5.000 grams
- Distance between impacting element and the part under test: 40 cm
- Number of impacts: 5

1st impact test

2nd impact test

3rd impact

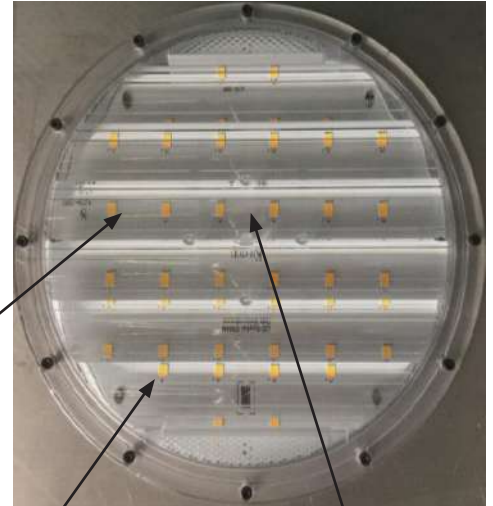

1st TEST



2nd TEST



3rd TEST

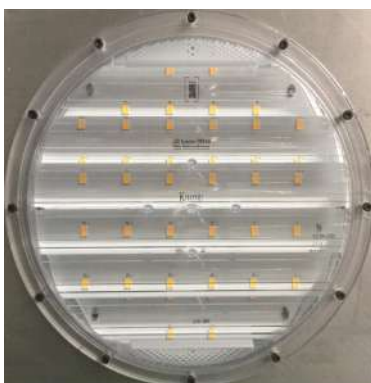

Final Visual Inspection:
After testing, a final visual inspection was performed. The result was positive. (view photo)

IP X5 Test

Note

The present document is an internal document showing the tests carried out by Khatod in its laboratory. The tests, photos and videos presented in this document are made available for demonstration purposes only. Khatod, with its laboratory, is not a certification body.

If customers need IP accredited certifications, they have to apply to the appointed Certification Bodies, under their sole care and responsibility.

Data and Analysis

The sample has been subjected to the water-penetration resistance test as follows:

- Assembly of the components to test :
A moisture indicator paper sheet has been interposed between the lens and the clamping base
- Positioning of the assembled sample under the device of watering with nozzle \varnothing 6.3 millimeters
- Water flow: 12.5 l/min \pm 5%
- Water pressure: 30 kPa @ distance of 3m
- Duration of the test to be sprayed for m² of surface wrap: 1 min
- Minimum duration of the test: 3 min
- Distance between the nozzle and wrap surface: 2.5m



PLL2215xx Assembled



Test Under Water Jet



Test Under Water Jet

Conclusion



The test paper sheet is dry

As shown in the photo, the test paper sheet is completely dry after disassembling the system.

Based on the water penetration resistance test, we can say that the Silicone Gasket KGAS2215 proved to be fit for purpose. The product has passed the Khatod test.

Packaging

Item	Quantity	Total Parts	Size (L*W*H)	G.W.
Multi-pocket plastic bag	1 piece per multi-pocket plastic bag	1 pcs	30*30 cm	0.371 Kg
Outer Box	20 multi-pocket plastic bags per Outer Box	20 pcs	58*33*33 cm	8,0 Kg



20 Lenses / Multi-pocket plastic bags



20 Multi-pocket plastic bags per Outer Box

Materials

Material	Top
PC 5.0	-40° ...120°C
PLL2215xx Temperature resistance: long-term	-40° ...90°C
PLL2215xx Temperature resistance: short exposure	up to + 108 °C

Notes:

- The optical values shown are the result of optical simulations carried out with LIGHTTOOLS, ASAP and ZEMAX software systems. The optical simulations are carried out on the basis of the typical values provided in the LED manufacturers' official datasheets. The photometric analysis has been carried out on physical samples. On request, by supplying your PCB, we can provide the measurement photometric file.

Use and Maintenance

- DO NOT HANDLE OR INSTALL LENSES WITHOUT WEARING GLOVES, SKIN OILS MAY DAMAGE LENS OR LIGHT TRANSMISSION;
- CLEAN LENSES WITH MILD SOAP AND WATER AND A SOFT CLOTH;
- DO NOT USE ANY COMMERCIAL CLEANING SOLVENTS ON LENSES.

Disclaimer

Please note that flow lines and weld lines on the external surfaces of the lenses are acceptable if the optical performance of the lens is within the specifications.

Should you require further information, please contact Khatod for advice. All lens testing must be subject to identical conditions as Khatod test condition. Khatod Optoelectronic, Milan, Italy, manufactures lenses for LEDs. Any other use of the lens shall void our liability and warranty. The lenses are an inert component to be used in the manufacture of various products. Our warranty and liability are limited only to the manufacture of the lens. You may not modify, copy, distribute reproduce, license or alter the lens and related materials of Khatod. Khatod does not warrant against damages or defects arising out of the use or misuse of the products; against defects or damage arising from improper installation, or against defects in the product or in its components. No warranty of any kind, expressed or implied, is made regarding the safety of the products. The entire risk as to the quality or performance of the product is with the buyer. In no event

shall Khatod be liable for any direct, indirect, punitive, incidental, special, consequential damages, or any damages whatsoever arising out of or connected with the use or misuse of the product. Khatod shall not have any obligation with respect to the product or any part thereof, whether based on contract, tort, strict liability or otherwise. Buyer assumes all risks and liability from use of the product. The laws of Milan, Italy govern this product warranty and liability and you hereby consent to the exclusive jurisdiction and venue of courts in Milan, Italy in all disputes arising out of or relating to the use of this product. Production, marketing, distribution, sale of these products as well as their possible modifications and variations are only exclusive right of Khatod Optoelectronic. No company can perform any of these actions without written permission released by Khatod Optoelectronic. The information contained in this document is proprietary of Khatod Optoelectronic and may change without notice.