

## PLL2091WIUV - 30° FWHM

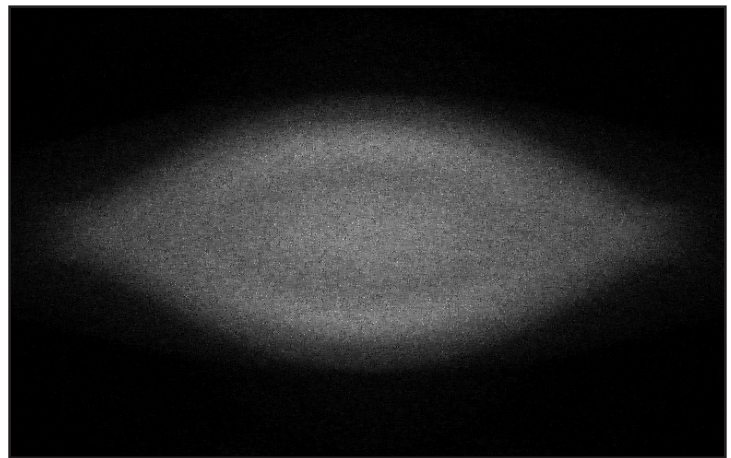

- Material = PMMA UV
- Full angle C0-C180 at 50% from maximum: ~ 27x100°
- The light spots here represented refer to tests carried out with 22 LEDs, 3x3mm size, without Dome

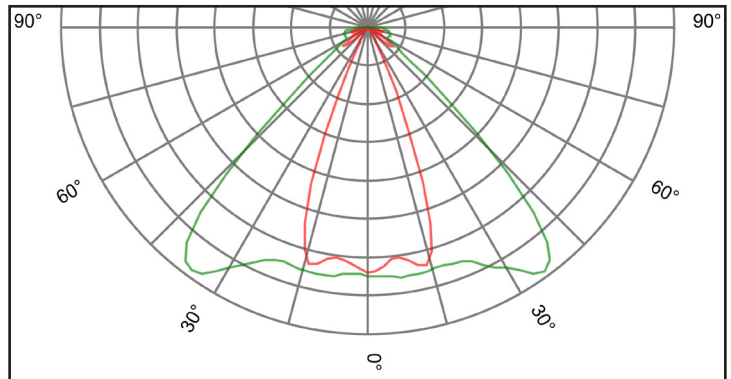
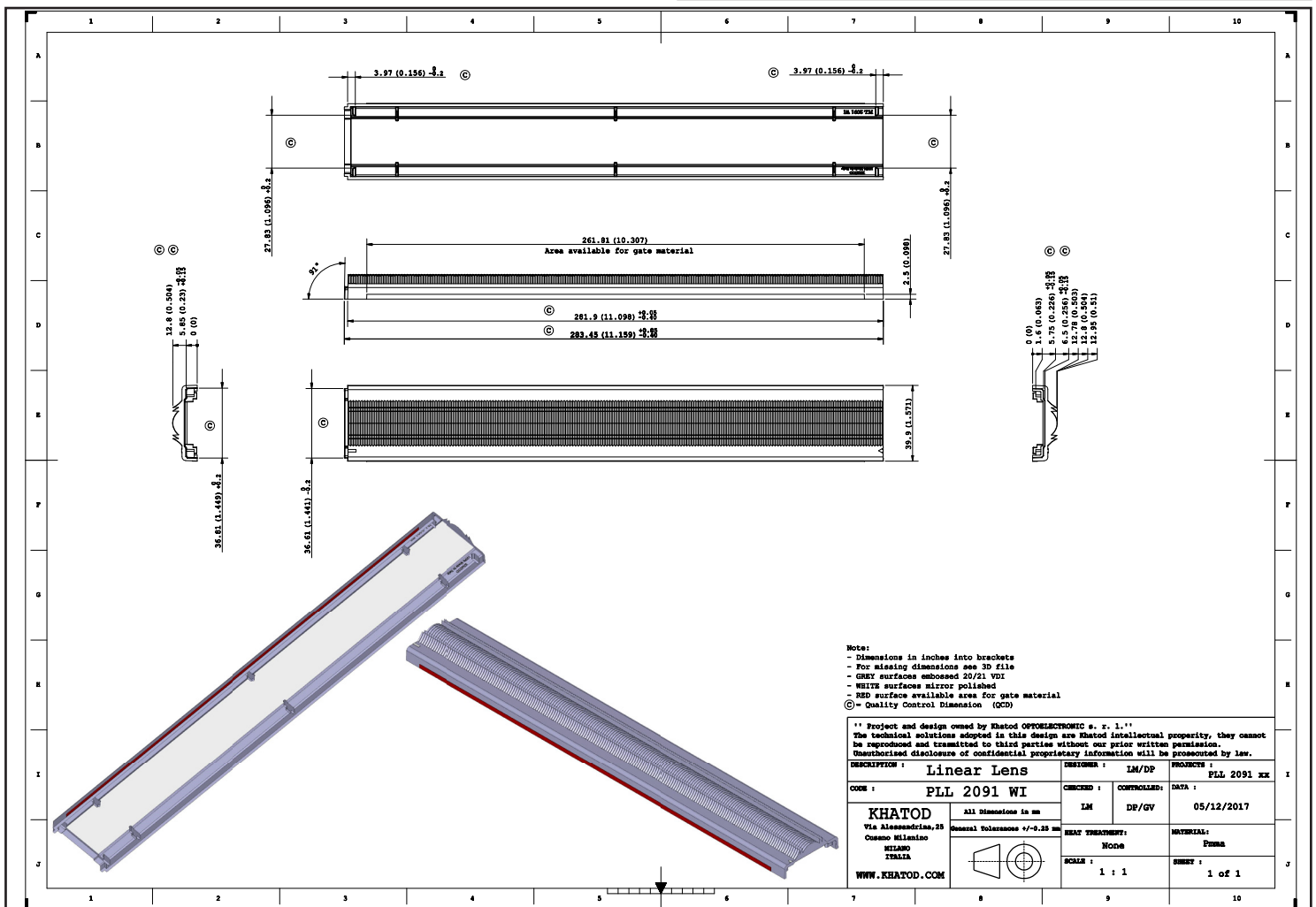

## Assembly specification

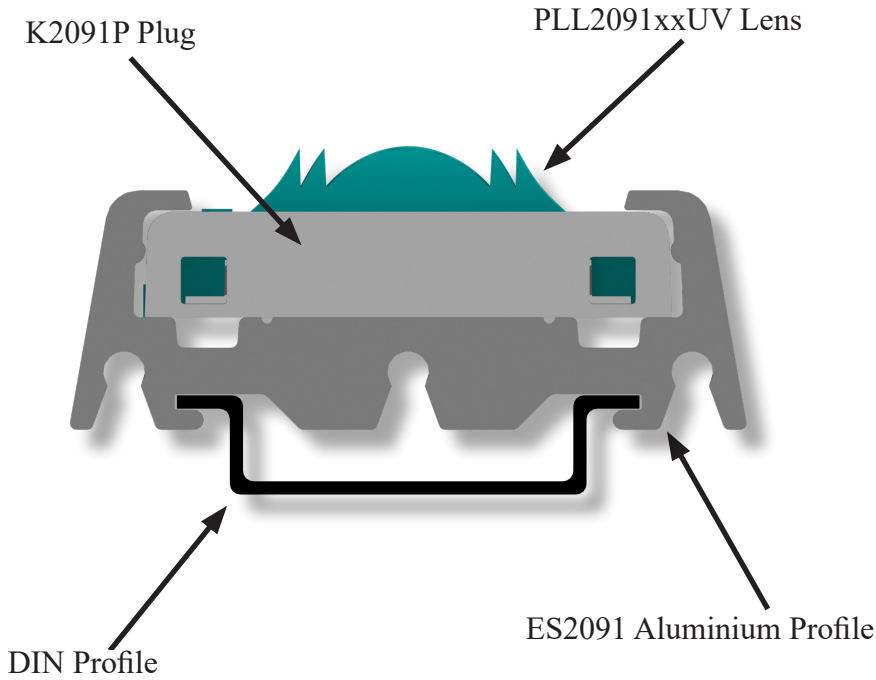

PLL2091xxUV Lens series is compatible with DIN Profile Standards:

- DIN 1010
- DIN 1065
- DIN 3065
- DIN 1015
- DIN 1070
- DIN 3070

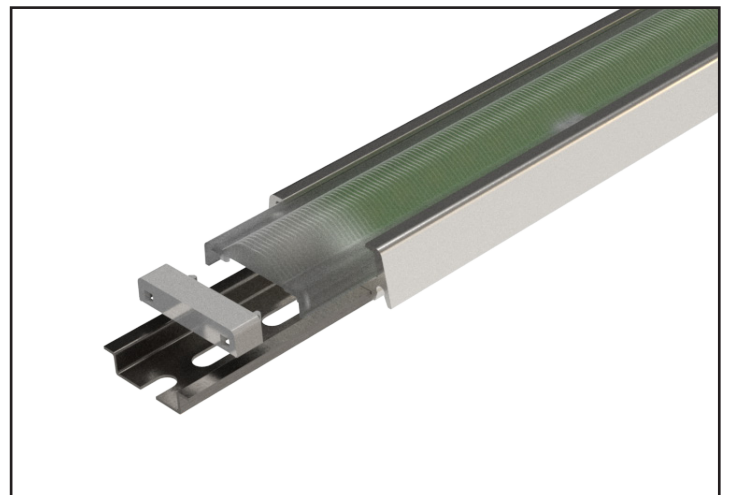
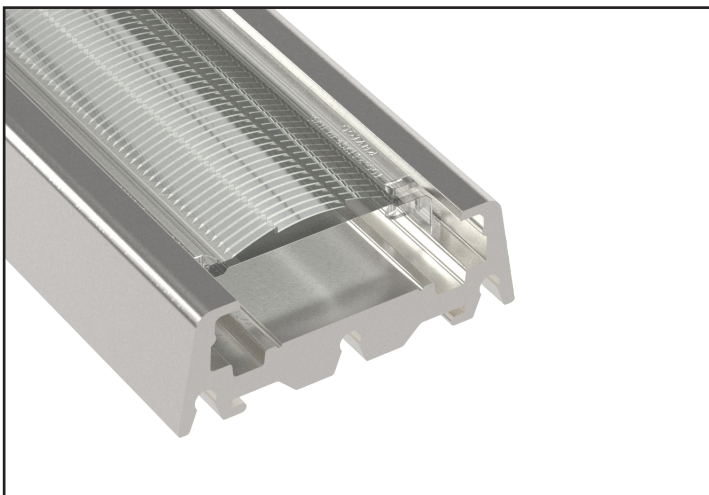
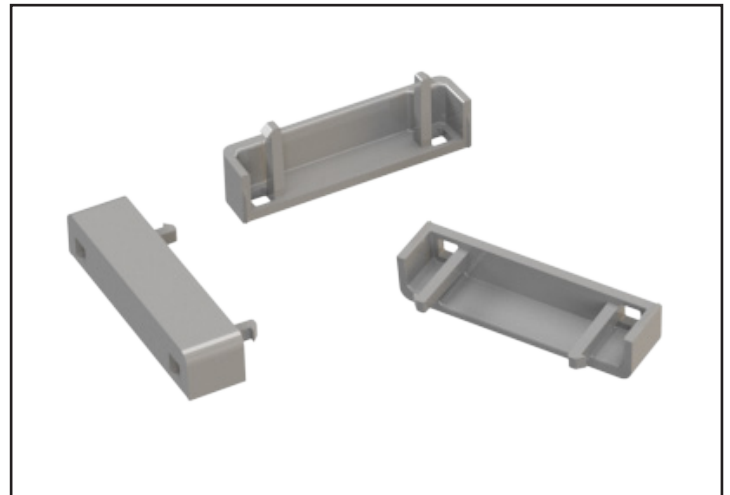
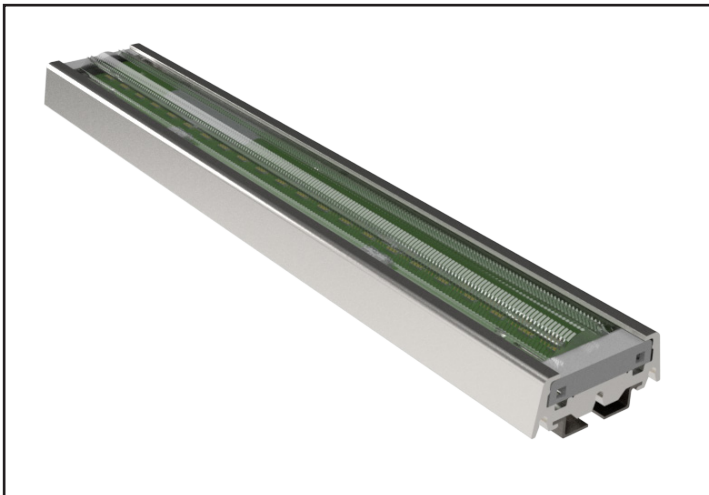

## Materials

### PMMA UV Optics MP1000025

	Parameter	Unit	Standard	PMMA UV
<b>Mechanical Properties</b>				
Tensile Modulus	1 mm/min	MPa	ISO 527	3200
Stress @ Break	5 mm/min	MPa	ISO 527	76
Strain @ Break	5 mm/min	%	ISO 527	5.5
Charpy Impact Strength	23°C	kJ/m <sup>2</sup>	ISO 179/1eU	20
<b>Thermal Properties</b>				
Vicat Softening Temperature	B / 50	°C	ISO 306	103
Glass Transition Temperature		°C	ISO 11357	112
Temp. of Deflection under Load	0.45 MPa	°C	ISO 75	100
Temp. of Deflection under Load	1.8 MPa	°C	ISO 75	95
Coeff. of Linear Therm. Expansion	0 - 50°C	E-5 /°K	ISO 11359	8
Classes of construction product			DIN EN 13501-1	E
Flammability UL 94	1.5 mm	Class	IEC 60695-11-10	HB
<b>Rheological Properties</b>				
Melt Volume Rate, MVR	230°C / 3.8kg	cm <sup>3</sup> /10min	ISO 1133	1.4
<b>Optical Properties</b>				
Luminous transmittance	d=3 mm			
Luminous transmittance	D65	%	ISO 13468-2	92
Haze			ASTM D1003	< 0.5
Refractive Index	589nm/23°C		ISO 489	1.49
<b>Other Properties</b>				
Density		g/cm <sup>3</sup>	ISO 1183	1.19
<b>Recommended Processing Conditions</b>				
Predrying Temperature		°C		max. 93
Predrying Time in Desiccant-Type Drier		h		2 - 3
Melt Temperature		°C		220 - 260
Die Temperature (Extrusion)		°C		220 - 260

Transmission in the UV- and VIS- area  
PMMA UV - Polymethylmethacrylate  
thickness 3 mm

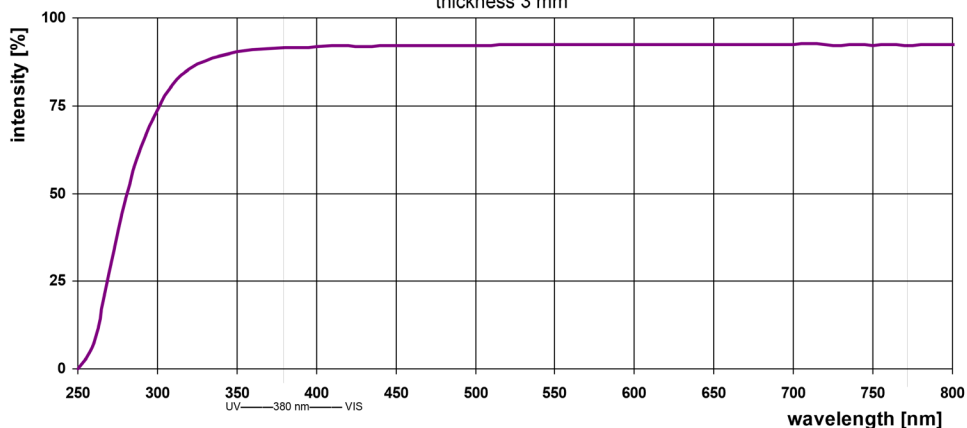

## Notes:

- The optical values shown are the result of optical simulations carried out with LIGHTTOOLS, ASAP and ZEMAX software systems. The optical simulations are carried out on the basis of the typical values provided in the LED manufacturers' official datasheets. The photometric analysis has been carried out on physical samples. On request, by supplying your PCB, we can provide the measurement photometric file.

## Use and Maintenance

- DO NOT HANDLE OR INSTALL LENSES WITHOUT WEARING GLOVES, SKIN OILS MAY DAMAGE LENS OR LIGHT TRANSMISSION;
- CLEAN LENSES WITH MILD SOAP AND WATER AND A SOFT CLOTH;
- DO NOT USE ANY COMMERCIAL CLEANING SOLVENTS ON LENSES.

## Disclaimer

Please note that flow lines and weld lines on the external surfaces of the lenses are acceptable if the optical performance of the lens is within the specifications.

Should you require further information, please contact Khatod for advice. All lens testing must be subject to identical conditions as Khatod test condition. Khatod Optoelectronic, Milan, Italy, manufactures lenses for LEDs. Any other use of the lens shall void our liability and warranty. The lenses are an inert component to be used in the manufacture of various products. Our warranty and liability are limited only to the manufacture of the lens. You may not modify, copy, distribute reproduce, license or alter the lens and related materials of Khatod. Khatod does not warrant against damages or defects arising out of the use or misuse of the products; against defects or damage arising from improper installation, or against defects in the product or in its components. No warranty of any kind, expressed or implied, is made regarding the safety of the products. The entire risk as to the quality or performance of the product is with the buyer. In no event shall Khatod be liable for any direct, indirect, punitive, incidental, special, consequential damages, or any damages whatsoever arising out of or connected with the use or misuse of the product. Khatod shall not have any obligation with respect to the product or any part thereof, whether based on contract, tort, strict liability or otherwise. Buyer assumes all risks and liability from use of the product. The laws of Milan, Italy govern this product warranty and liability and you hereby consent to the exclusive jurisdiction and venue of courts in Milan, Italy in all disputes arising out of or relating to the use of this product. Production, marketing, distribution, sale of these products as well as their possible modifications and variations are only exclusive right of Khatod Optoelectronic. No company can perform any of these actions without written permission released by Khatod Optoelectronic. The information contained in this document is proprietary of Khatod Optoelectronic and may change without notice.

REPRODUCTION PROHIBITED.