

Via Monfalcone 41
20092 Cinisello Balsamo (Milano) – Italy
Tel. +39 0266013695 – Fax +39 0266013500

MODEL NO: PL5271xx Series

SUBJECT: **OSRAM[®] OSTAR[®] LEDs with Star – Lens Coupling - Output Luminous Intensity Measurement**



PL5271xx Series for OSTAR[®]

- High efficiency
- No vibration problems
- Free testing

Typical applications are

- Architectural lighting
- Lamps
- Street lights
- Most applications where a compact light source is required

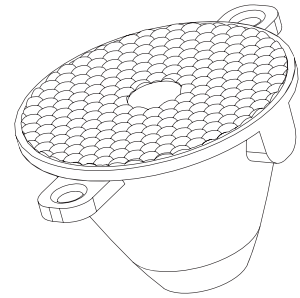

DESCRIPTION:

Verification of Luminous Intensity with coupling conditions between Khatod lenses and OSRAM[®] OSTAR[®] LEDs White mod. LEWE3B-NYPY-6K8L bin PX-7L-0.

REPORT:

From 1 m ± 0,02 distance, we have measured Luminous Intensity emitted by LED. Such measurements have been repeated with the same test conditions but coupling LEDs to the lens Khatod cod. PL527106, PL527125, PL527140 and PL527125LSD.

MEASURED DATA:

Column 1 shows p/n of the Lenses, column 2 shows Luminous Intensity detected measuring LEDs without lens, column 3 shows Luminous Intensity detected on LEDs coupled with lens, column 4 shows the difference (X*) between col. 2 and col. 3

| Lens Type | LED Lux from 1 Mt (ftc From 1 Mt) | LED + lens Lux from 1Mt (ftc From 1 Mt) | X* |
|-------------------|---|---|----|
| PL527106 (10°) | 66 (6,09 ftc) | 1400 (129,21 ftc) | 21 |
| PL527125 (25°) | 66 (6,09 ftc) | 765 (70,60 ftc) | 11 |
| PL527140 (40°) | 66 (6,09 ftc) | 594 (54,82 ftc) | 9 |
| PL527125LSD (30°) | 66 (6,09 ftc) | 792 (67,28 ftc) | 12 |

Test carried out after 5 min. of operation of the LED to 700 mA ~ , local power source **GOSSON KONSTANTER** mod 3226-K118
Measurements carried out with Luxometer mod LUX-1337 of **ISO-TEC** and **MINOLTA** mod LS – 150

* X is the value of the measurement of the LED brightness at 1 meter distance, without optic devices applied to the LED.

White LED Illuminance Chart

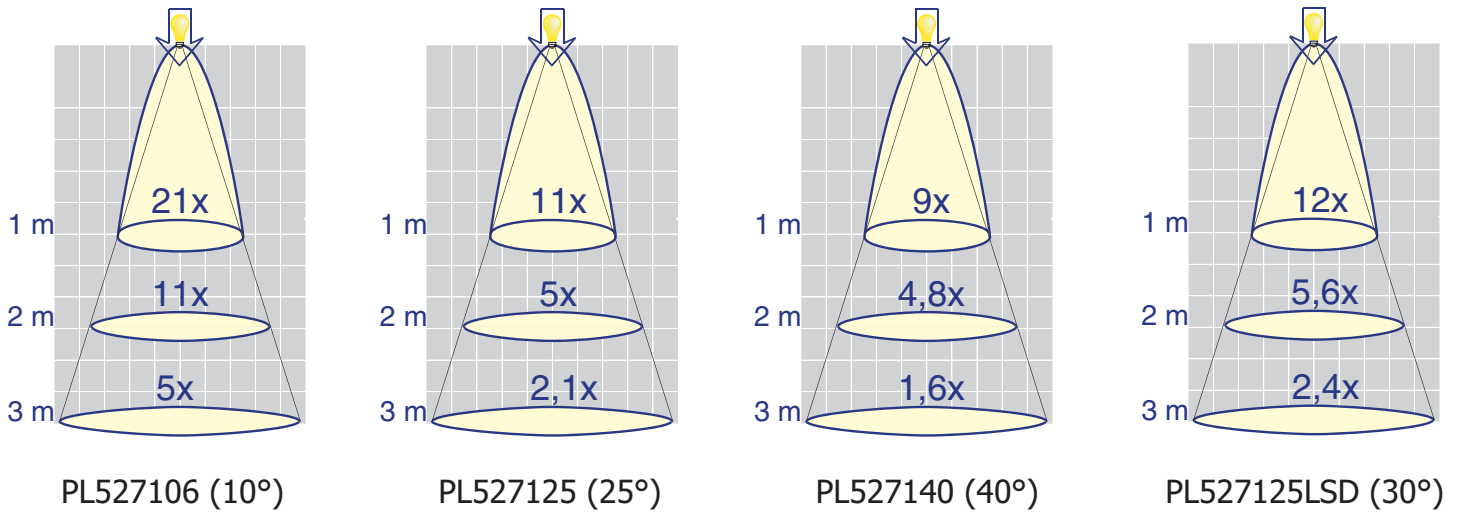

* X is the value of the measurement of the LED brightness at 1 meter distance, without optic devices applied to the LED.

Test conditions:
 Test current: 700 mA / LED
 Room Luminous Intensity : 0 Lumen
 Room Temperature: 17,6° C
 LED temperature after 10 min. : ~ 48 °C

The diagram demonstrates the performance of the Khatod optoelectronic lenses

Intensity to 1 Meter

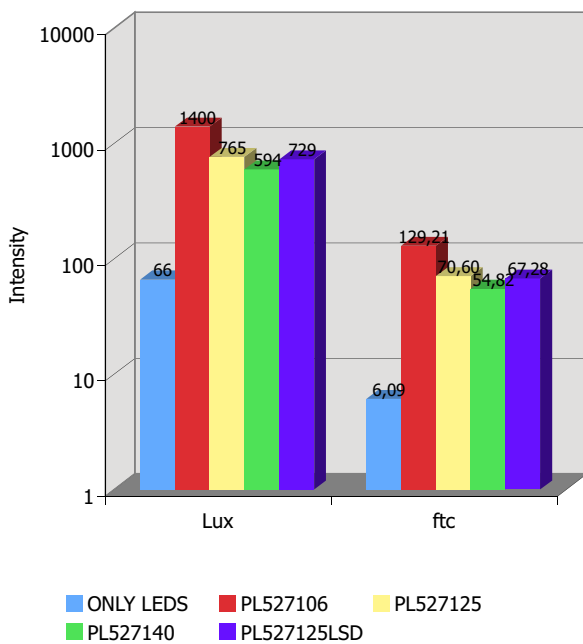

Spectrum Distribution

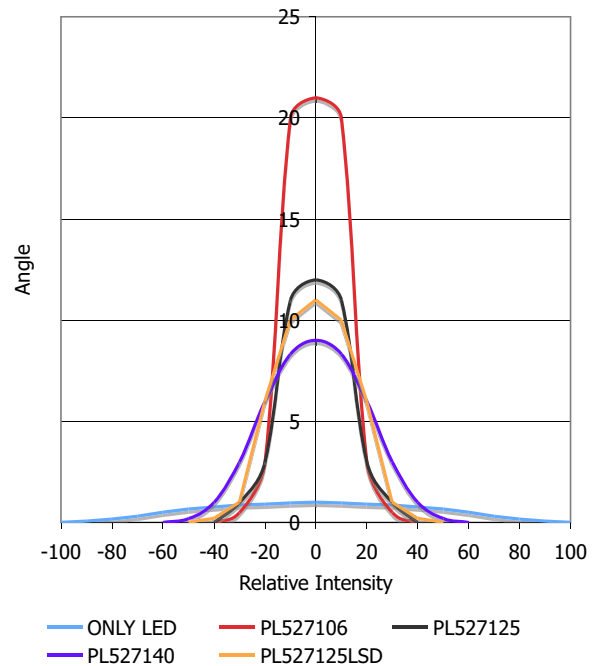

Photos:

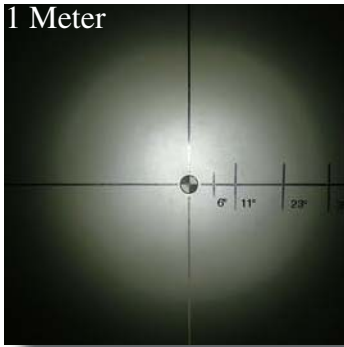

PL527106 (10°)

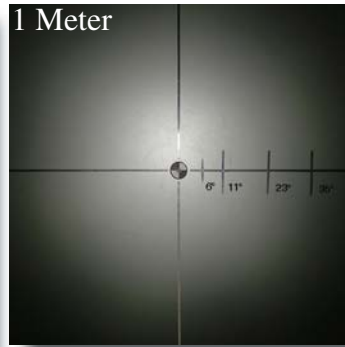

PL527125 (25°)

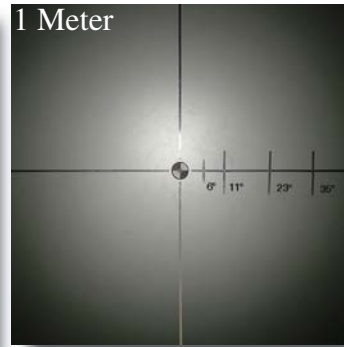

PL527140 (40°)

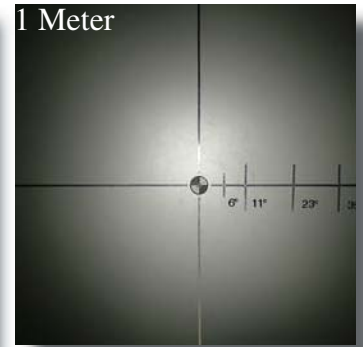

PL527125LSD (30°)

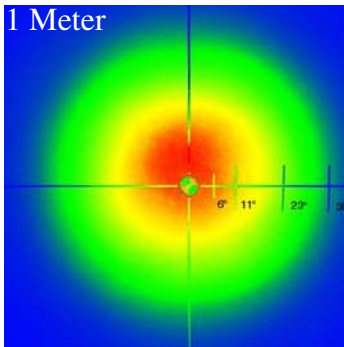

PL527106 (10°)
Spectro Metric Analysis

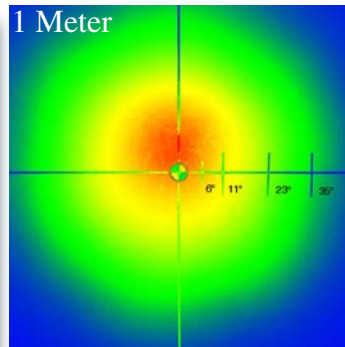

PL527125 (25°)
Spectro Metric Analysis

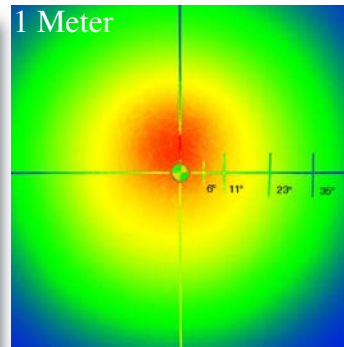

PL527140 (40°)
Spectro Metric Analysis

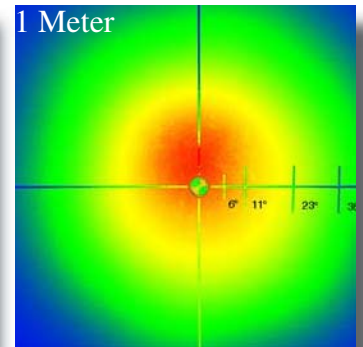

PL527125LSD (30°)
Spectro Metric Analysis

Measurements carried out with Luxometer mod LUX-1337. Room Luminous Intensity: 0 Lumen. Camera mod. Fujifilm S7000

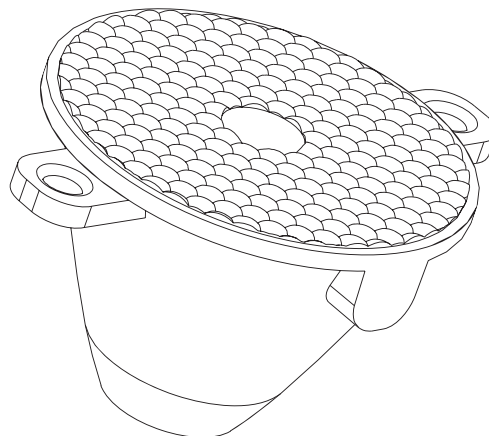

Drawing.

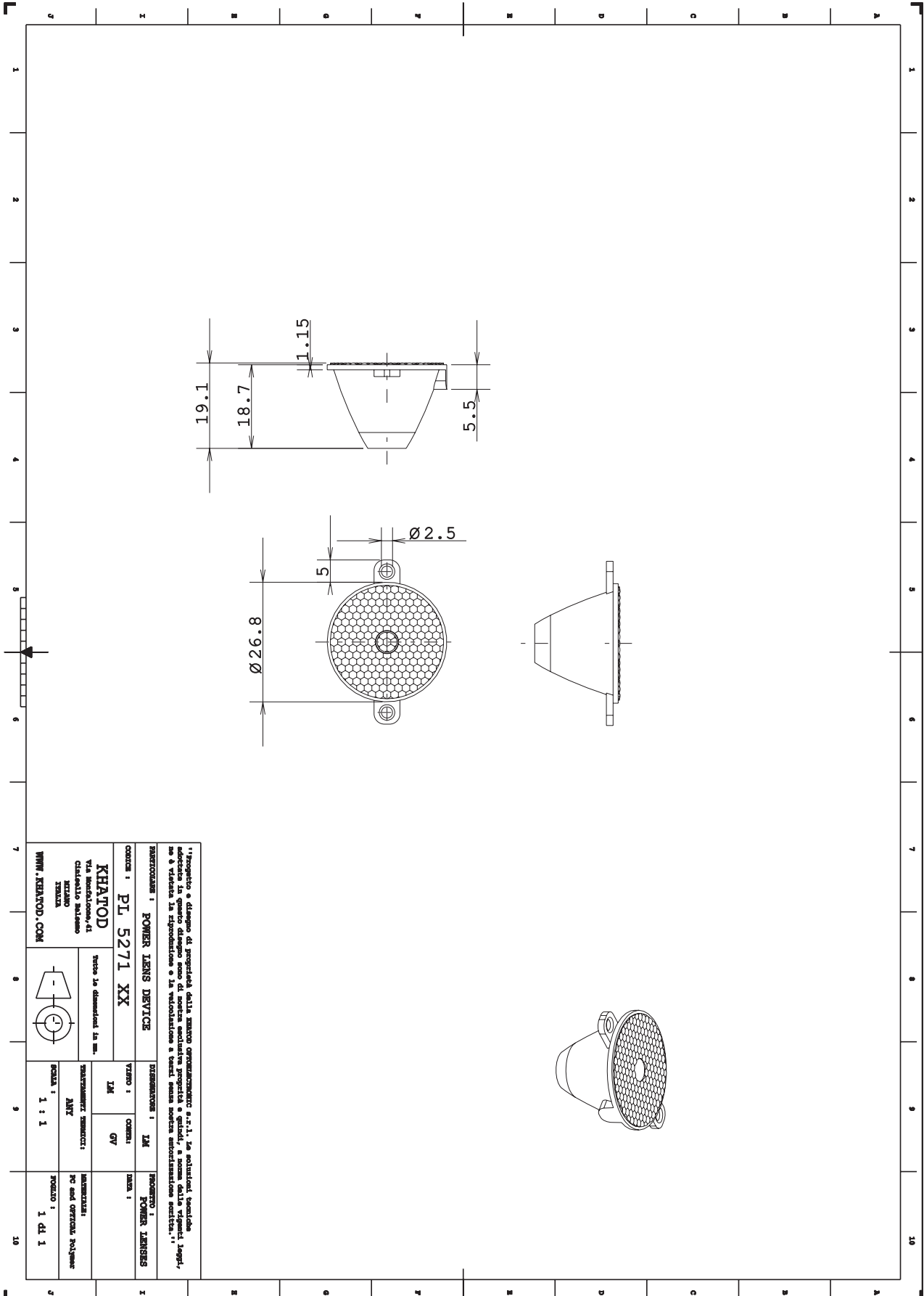

Lens characteristics

| Parameter | Symbol | Rating | Unit |
|---|-------------|------------|------|
| Lens Material | PMMA Optics | -- | -- |
| Holder Material | -- | -- | -- |
| Operating Temperature | Topr | -40 to +80 | °C |
| Storage Temperature | Tstg | -40 to +80 | °C |
| Average transmittance in visible spectrum (400 – 700nm) >90% as measured using 3mm thick Optical Grade PMMA | | | |

LED characteristics

For technical specification on LEDs please refer to OSRAM® LEDs datasheet or visit www.osram-os.com

Notes:

Please note that flow lines and weld lines on the external surfaces of the lenses are acceptable if the optical performance of the lens is within the specification described in the section "OPTICAL CHARACTERISTICS"

- Should you require further information, please contact Khatod for advice.
- All lens testing must be subject to identical conditions as Khatod test condition.
- Published by Khatod optoelectronic srl - All the data contained in this document are the property of Khatod optoelectronic srl and may change without notice.

KHATOD LENS Use And Maintenance

- DO NOT HANDLE OR INSTALL LENSES WITHOUT WEARING GLOVES, SKIN OILS MAY DAMAGE LENS OR LIGHT TRANSMISSION
- CLEAN LENSES WITH MILD SOAP AND WATER AND A SOFT CLOTH
- DO NOT USE ANY COMMERCIAL CLEANING SOLVENTS ON LENSES

Khatod SRL, Milan, Italy, manufactures lenses for LEDs. Any other use of the lens shall void our liability and warranty. The lenses are an inert component to be used in the manufacture of various products. Our warranty and liability are limited only to the manufacture of the lens. You may not modify, copy, distribute reproduce, license or alter the lens and related materials of Khatod SRL. Khatod SRL does not warrant against damages or defects arising out of the use or misuse of the products; against defects or damage arising from improper installation, or against defects in the product or in its components. No warranty of any kind, expressed or implied, is made regarding the safety of the products. The entire risk as to the quality or performance of the product is with the buyer. In no event shall Khatod SRL or Khatod USA be liable for any direct, indirect, punitive, incidental, special, consequential damages, or any damages whatsoever arising out of or connected with the use or misuse of the product. Khatod SRL shall not have any obligation with respect to the product or any part thereof, whether based on contract, tort, strict liability or otherwise. Buyer assumes all risks and liability from use of the product. The laws of Milan, Italy govern this product warranty and liability and you hereby consent to the exclusive jurisdiction and venue of courts in Milan, Italy in all disputes arising out of or relating to the use of this product.