

# KHATOD<sup>®</sup>

Optical Solutions for LED Lighting

Via Monfalcone, 41  
20092 Cinisello Balsamo - Milan - Italy  
technical@khatod.com  
Tel. (+39) 02-660-136-95  
Fax. (+39) 02-660-135-00

## Test Report

Number: 140000000013

Optics: PL1699NA

Source: LUMILEDS LUXEON Z ES

## **Contents**

|           |   |          |
|-----------|---|----------|
| <b>1</b>  | <b>Light Source Model</b>               | <b>3</b> |
| <b>2</b>  | <b>Measurement Setup</b>                | <b>3</b> |
| <b>3</b>  | <b>Results</b>                          | <b>3</b> |
| <b>4</b>  | <b>Intensity Plot</b>                   | <b>4</b> |
| <b>5</b>  | <b>Illuminance Map</b>                  | <b>5</b> |
| <b>6</b>  | <b>Isolux / Isocandela Plots</b>        | <b>6</b> |
| <b>7</b>  | <b>Illuminance Diagram</b>              | <b>7</b> |
| <b>8</b>  | <b>Drawing</b>                          | <b>8</b> |
| <b>9</b>  | <b>Materials</b>                        | <b>9</b> |
| <b>10</b> | <b>Use, Maintenance, and Disclaimer</b> | <b>9</b> |

## 1 Light Source Model

| Parameter                      | Symbol | Value                | Unit |
|--------------------------------|--------|----------------------|------|
| Lens / Reflector Model         | -      | PL1699NA             | -    |
| Material (More info on page 9) | -      | PC                   | -    |
| Dimensions                     | -      | See page 8           | -    |
| Source Model                   | -      | LUMILEDS LUXEON Z ES | -    |
| Number of Sources              | $N$    | 1                    | -    |
| Power Supply Type              | -      | ISO TECH ISP3303     | -    |
| Driver Type                    | -      | -                    | -    |
| Driving Voltage                | $V_F$  | -                    | V    |
| Driving Current                | $I_F$  | -                    | mA   |
| Nominal Flux                   | $\Phi$ | 200×1                | lm   |

## 2 Measurement Setup

| Parameter            | Symbol | Value        | Unit |
|----------------------|--------|--------------|------|
| Operator             | -      | Simone Bassi | -    |
| Goniophotometer Type | -      | KLX12M       | -    |
| Measurement Distance | $z$    | 5            | m    |
| Room Temperature     | $T$    | 25           | °C   |
| Date                 | -      | 2013-Dec-24  | -    |

## 3 Results

| Parameter                                 | Symbol                  | Value | Unit |
|---|-------------------------|-------|------|
| Total Flux                                | $\Phi$                  | 200   | lm   |
| Max Intensity                             | $I_{\max}$              | 482   | cd   |
| Max Illuminance at 5 m                    | $E_{\max}$              | 19    | lx   |
| C-Viewing Angle at 50% $I_{\max}$         | $2\varphi_C$            | 25    | °    |
| $\gamma$ -Viewing Angle at 50% $I_{\max}$ | $2\varphi_\gamma$       | 25    | °    |
| C-Viewing Angle at 10% $I_{\max}$         | $2\varphi_{C10\%}$      | 53    | °    |
| $\gamma$ -Viewing Angle at 10% $I_{\max}$ | $2\varphi_{\gamma10\%}$ | 58    | °    |
| General Optical Measurement Tolerance     | -                       | ±10%  | -    |

NOTES:

- Intensity ( $I$ ) and illuminance ( $E$ ) data are normalized by 1000 lm

## 4 Intensity Plot

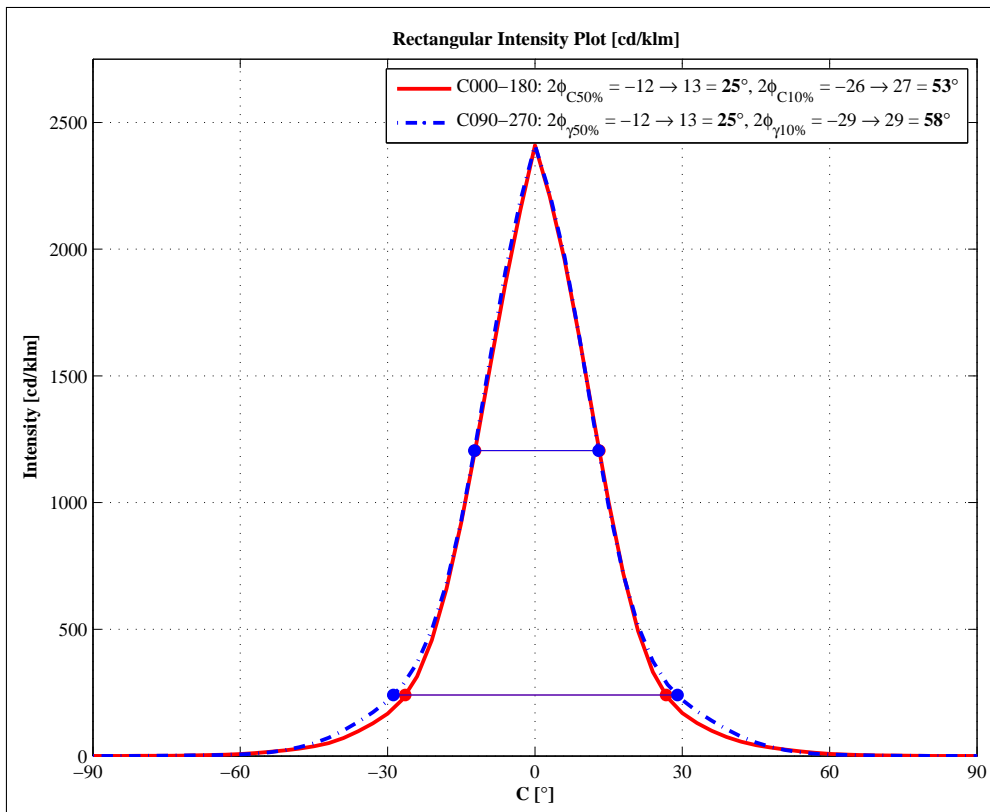
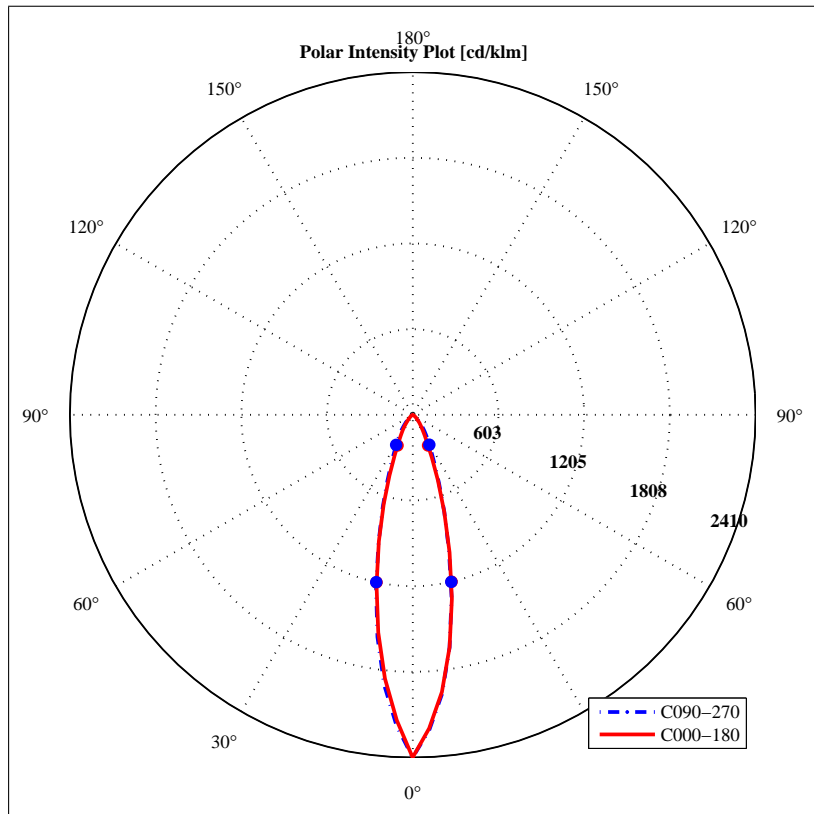

## 5 Illuminance Map

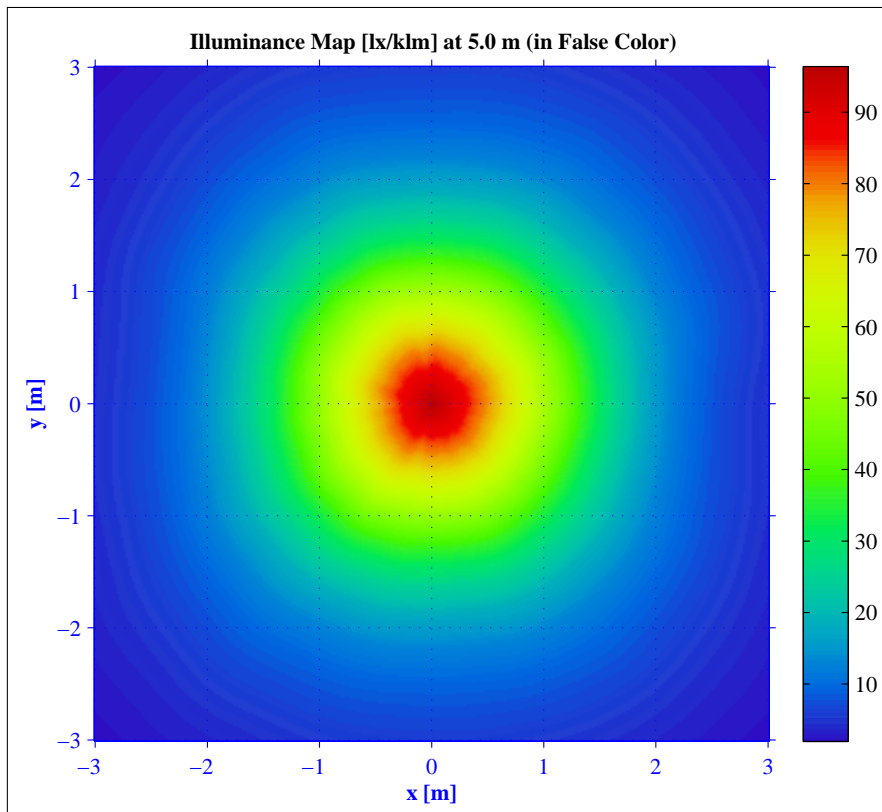
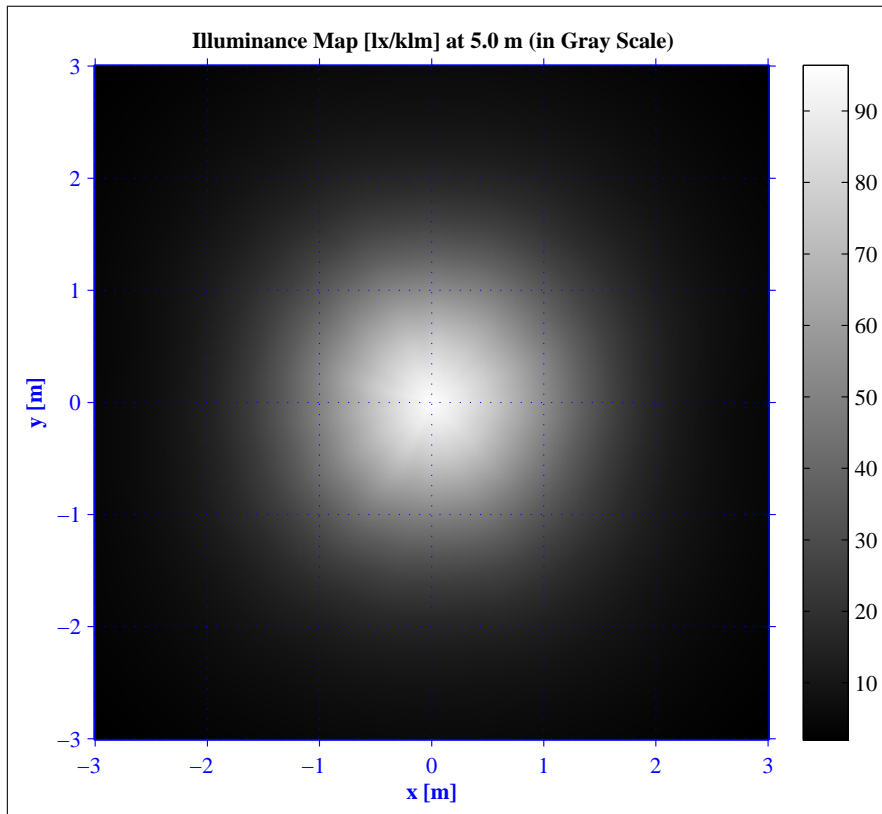

## 6 Isolux / Isocandela Plots

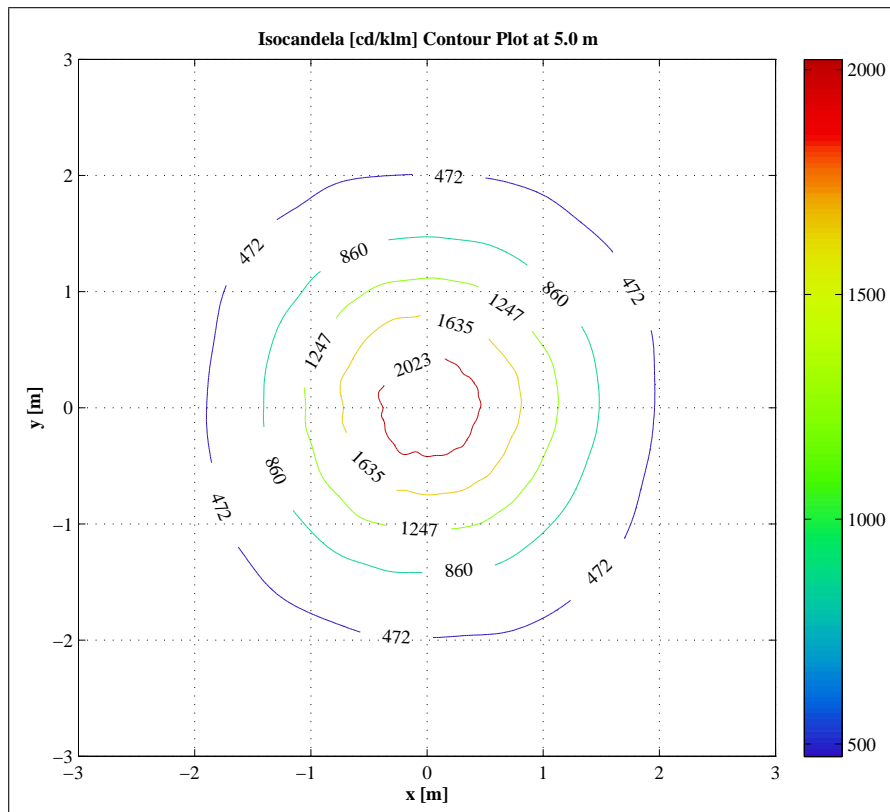
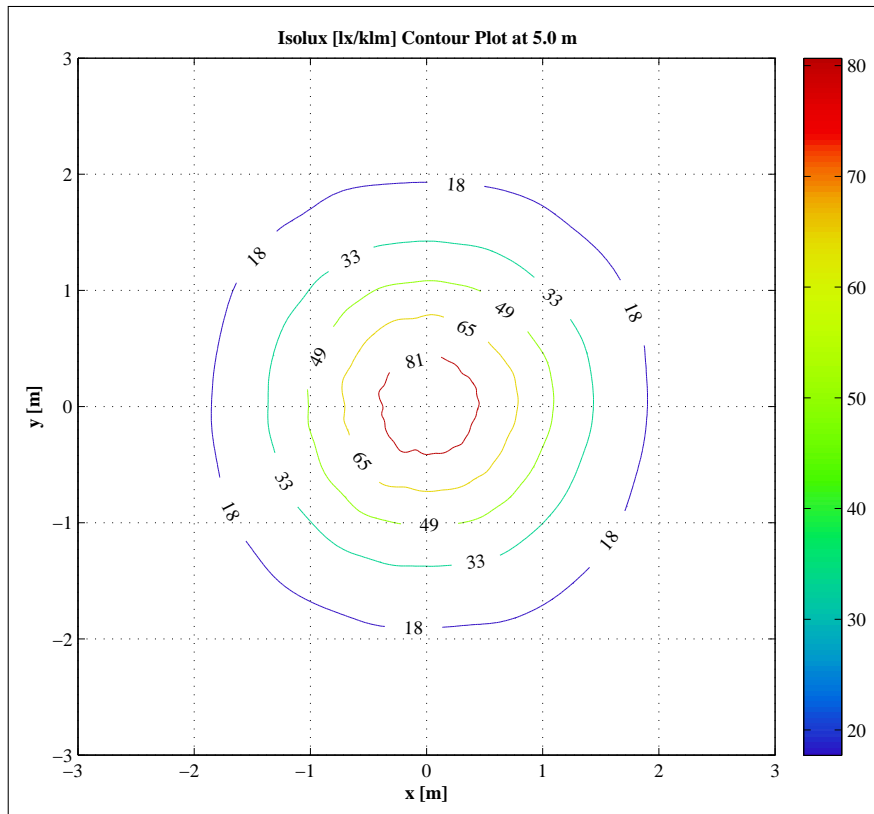

## 7 Illuminance Diagram

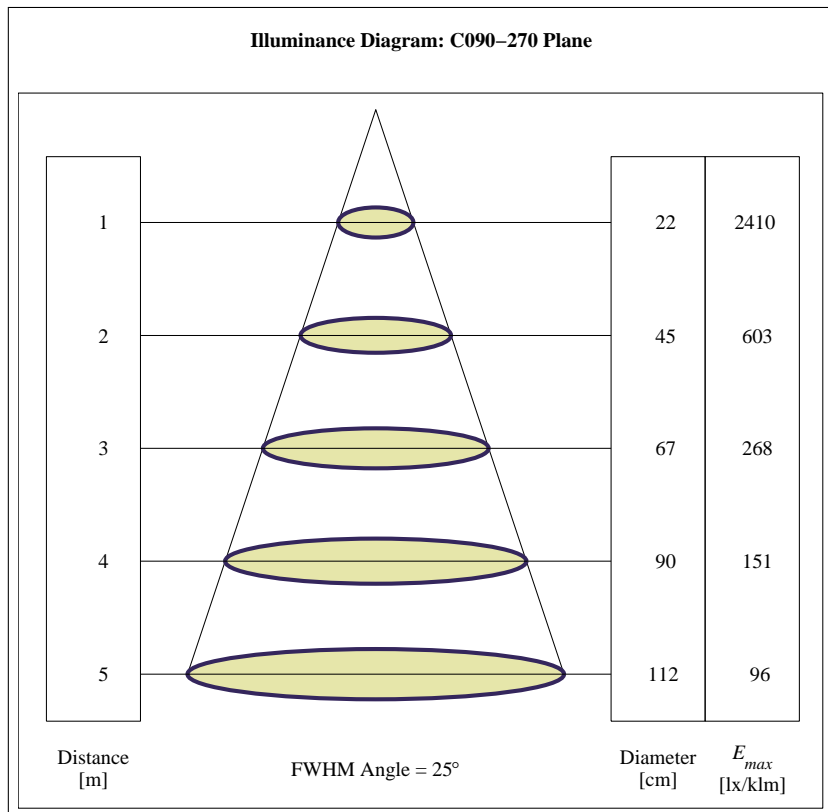
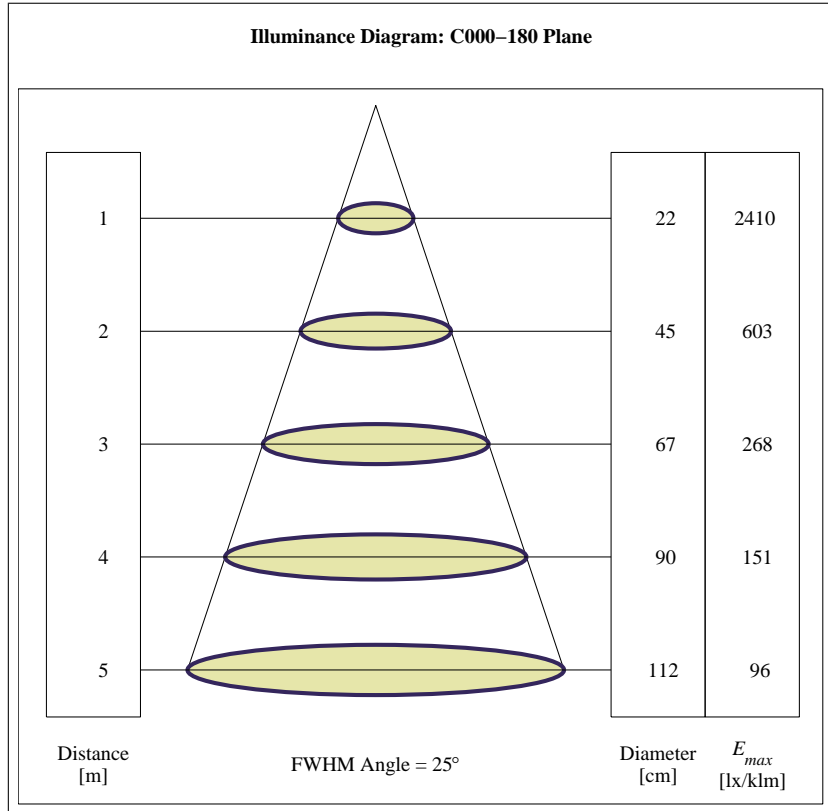

# 8 Drawing

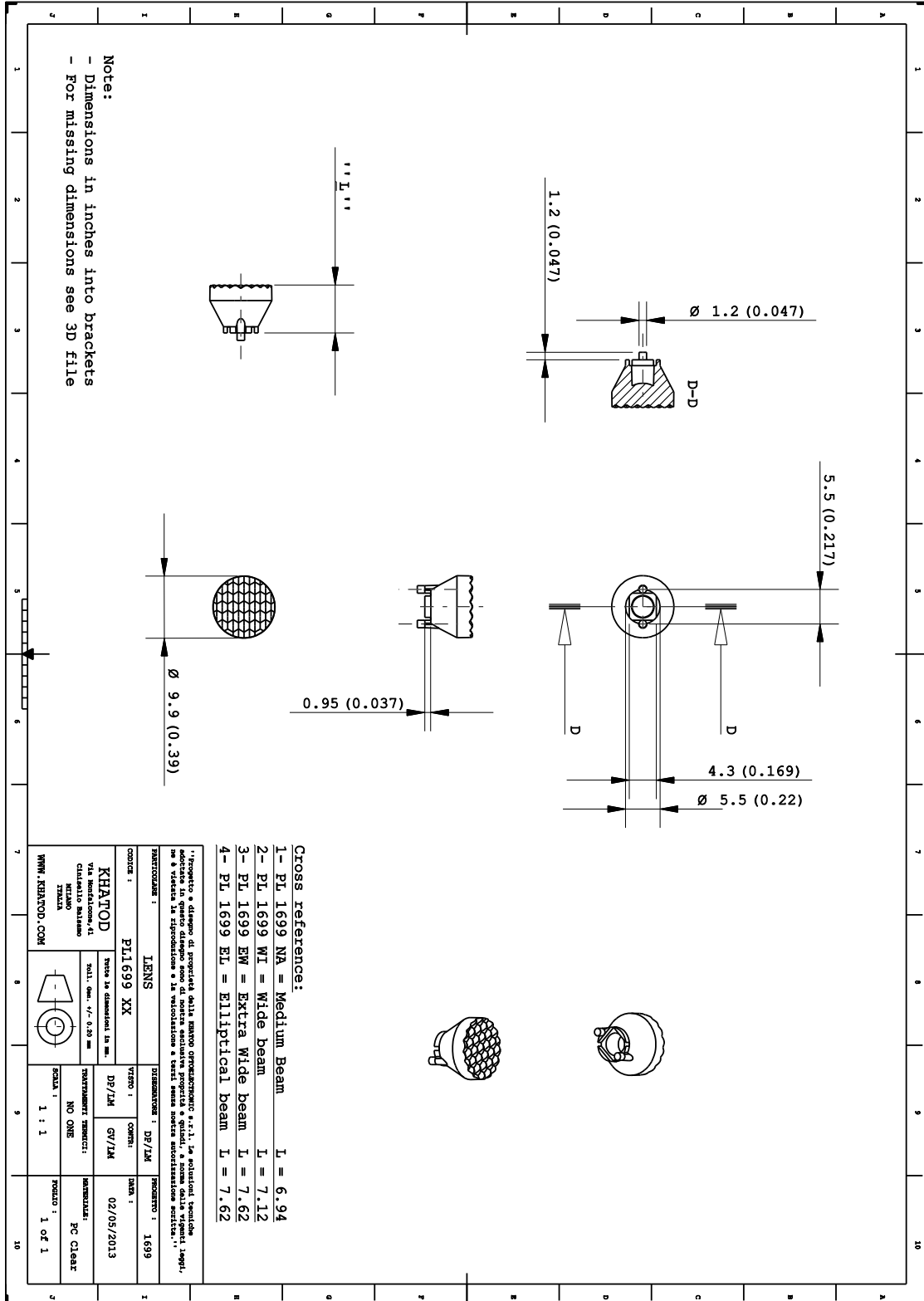



## 9 Materials

| Material   | T <sub>op</sub> | T <sub>stg</sub> |
|--|-----------------|------------------|
| PMMA   | -40°...85°C     | -40°...85°C      |
| PC   | -40°...120°C    | -40°...120°C     |
| PC + Aluminum Coating with protective Clear Coat   | -40°...120°C    | -40°...120°C     |
| APEC + Aluminum Coating with protective Clear Coat | -40°...180°C    | -40°...180°C     |
| ABS  | -35°...70°C     | -35°...70°C      |

## 10 Use, Maintenance, and Disclaimer

Do not handle or install lenses without wearing gloves, skin oils may damage lens or light transmission. Clean lenses with mild soap and water and a soft cloth. Do not use any commercial cleaning solvents on lenses.

The optical values shown are the result of optical simulations carried out with ASAP and ZEMAX software systems. The optical simulations are carried out on the basis of the typical values provided in the LED manufacturers' official datasheets. The photometric analysis has been carried out on physical samples. On request, by supplying your PCB, we can provide the measurement photometric file.

Please note that flow lines and weld lines on the external surfaces of the lenses are acceptable if the optical performance of the lens is within the specification described in the section Results on page 3. Should you require further information, please contact Khatod for advice. All lens testing must be subject to identical conditions as Khatod test condition.

Khatod Optoelectronic, Milan, Italy, manufactures lenses for LEDs. Any other use of the lens shall void our liability and warranty. The lenses are an inert component to be used in the manufacture of various products. Our warranty and liability are limited only to the manufacture of the lens. You may not modify, copy, distribute reproduce, license or alter the lens and related materials of Khatod. Khatod does not warrant against damages or defects arising out of the use or misuse of the products; against defects or damage arising from improper installation, or against defects in the product or in its components. No warranty of any kind, expressed or implied, is made regarding the safety of the products. The entire risk as to the quality or performance of the product is with the buyer. In no event shall Khatod be liable for any direct, indirect, punitive, incidental, special, consequential damages, or any damages whatsoever arising out of or connected with the use or misuse of the product. Khatod shall not have any obligation with respect to the product or any part thereof, whether based on contract, tort, strict liability or otherwise. Buyer assumes all risks and liability from use of the product. The laws of Milan, Italy govern this product warranty and liability and you hereby consent to the exclusive jurisdiction and venue of courts in Milan, Italy in all disputes arising out of or relating to the use of this product. Production, marketing, distribution, sale of these products as well as their possible modifications and variations are only exclusive right of Khatod Optoelectronic. No company can perform any of these actions without written permission released by Khatod Optoelectronic.

The information contained in this document is proprietary of Khatod Optoelectronic and may change without notice.

**REPRODUCTION PROHIBITED.**