

Light Guides for front panel diam.5mm

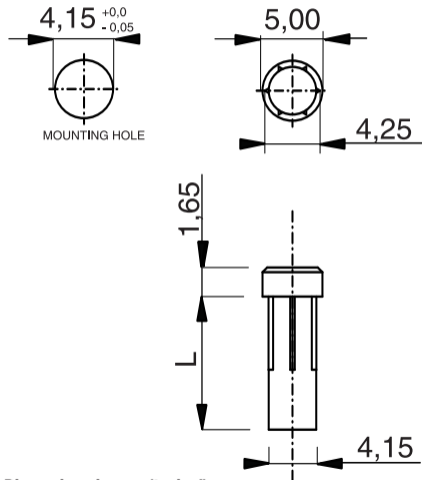

Dimensions in mm (typical)

Code

Length (L)

KPS165/070

7,0

KPS165/233

23,3

KPS165/XXX

insert your length

Hole panel: 4,15 mm 

Panel Thickness: 3,80 mm max

OPTIONS AVAILABLE

- ◆ Different shapes and lengths
- ◆ Different fixing systems on Panel
- ◆ Special color on request.