

Via Monfalcone 41
20092 Cinisello Balsamo (Milano) – Italy
Tel. +39 0266013695 – Fax +39 0266013500

KCLP series REFLECTORS for Lambertian



KCLP Series

- High efficiency
- Available in 2 different beams
- Ø 17mm and Ø 20mm Standard

Typical applications are

- Portable lighting (flashlights, bicycle, ...)
- Lamps
- Architectural lighting
- Most applications where a compact light source is required

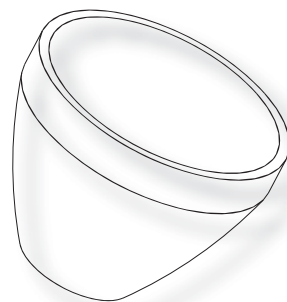

DESCRIPTION:

The KCLP series offers two reflectors designed for Lambertian LEDs. These REFLECTORS have been studied by using software for optical simulation in order to get the narrow and medium beam with a perfect homogeneous central spot.

REPORT:

From 1 m ± 0,02 distance, we have measured Luminous Intensity emitted by LED. Such measurements have been repeated with the same test conditions but coupling LEDs to the lens Khatod cod. KCLP17CR, KCLP17ST, KCLP20CR and KCLP20ST.

MEASURED DATA:

Column 1 shows p/n of the Lenses, column 2 shows Luminous Intensity detected measuring LEDs without lens, column 3 shows Luminous Intensity detected on LEDs coupled with lens, column 4 shows the difference (X*) between col. 2 and col. 3

Lens Type	LED Lux from 1 Mt (ftc From 1 Mt)	LED + REFLECTORS Lux from 1Mt (ftc From 1 Mt)	X*
KCLP17CR (6°)	11,25 (1,04 ftc)	388 (35,81 ftc)	35
KCLP17ST (35°)	11,25 (1,04 ftc)	135 (12,46 ftc)	12
KCLP20CR (6°)	11,25 (1,04 ftc)	580 (53,55 ftc)	52
KCLP20ST (25°)	11,25 (1,04 ftc)	225 (20,77 ftc)	20

Test carried out after 5 min. of operation of the LED to 350 mA ~ , local power source **GOSSON KONSTANTER** mod 3226-K118
Measurements carried out with Luxometer mod LUX-1337 of **ISO-TEC** and **MINOLTA** mod LS – 150

* X is the value of measurement of the LED brightness at 1 meter distance, without optic devices applied to the LED.

White LED Illuminance Chart

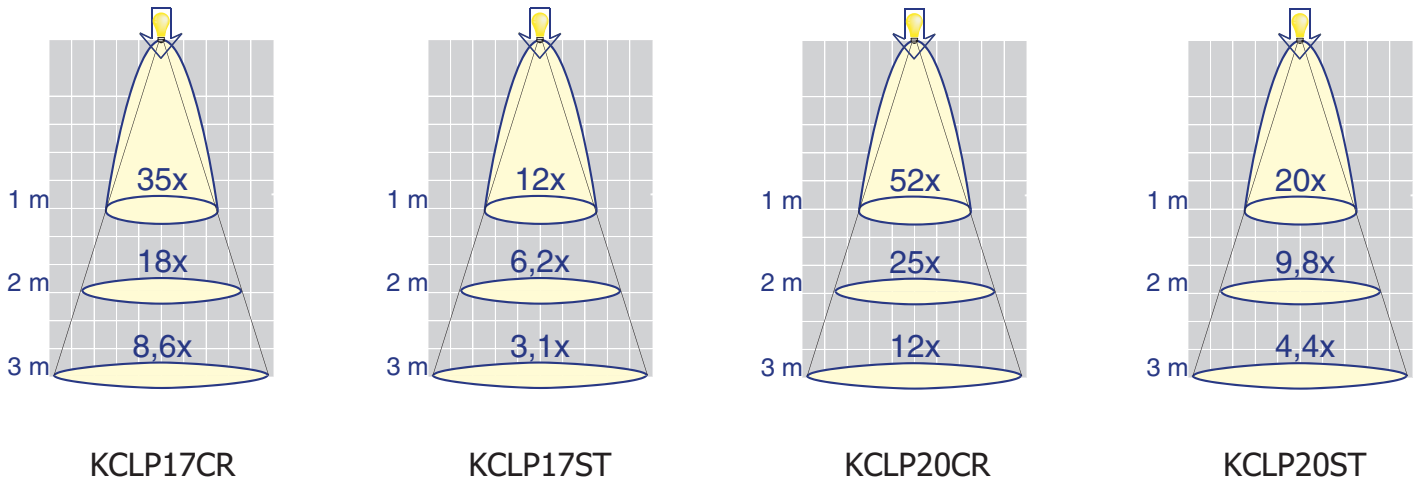

* X is the value of measurement of the LED brightness at 1 meter distance, without optic devices applied to the LED.

Test conditions:

Test current: 350 mA / LED
 Room Luminous Intensity : 0 Lumen
 Room Temperature: 23° C
 LED temperature after 10 min. : ~ 42 °C

The diagram demonstrates the performance of the Khatod optoelectronic reflectors

Intensity to 1 Meter

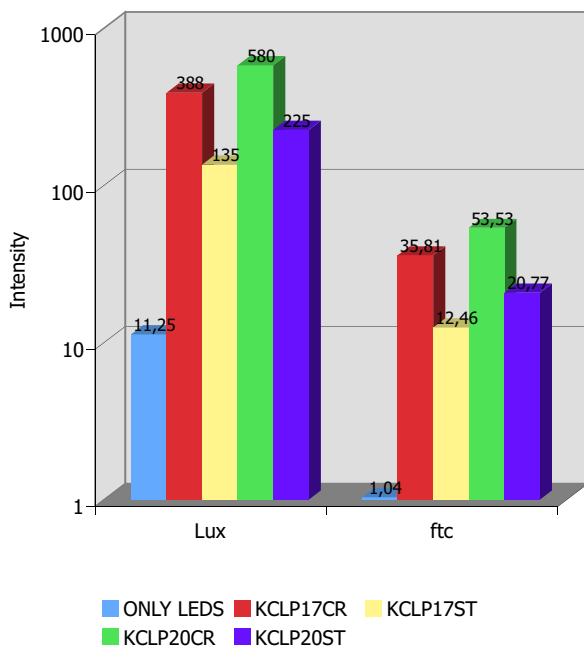

Spectrum Distribution

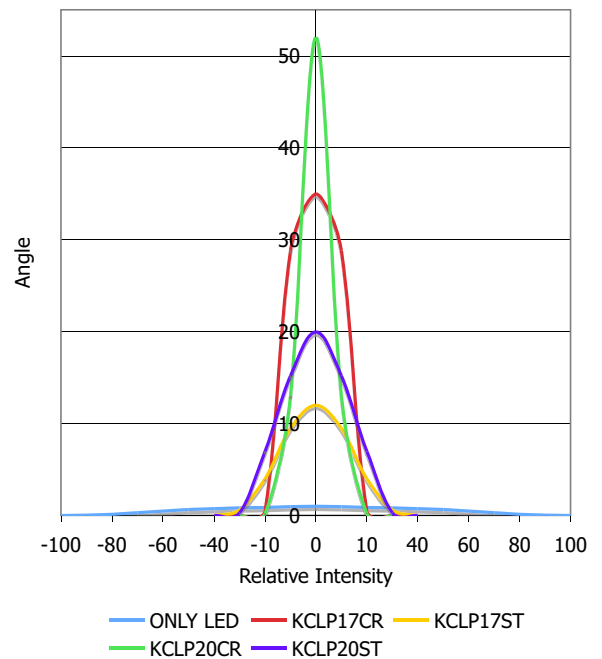

Photos:

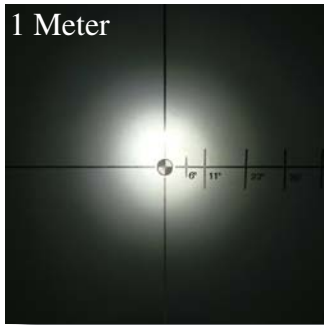

KCLP17CR

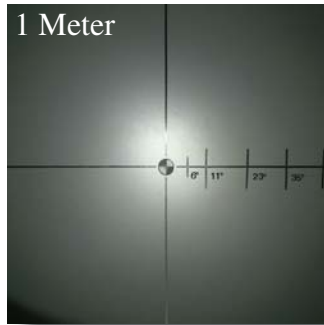

KCLP17ST

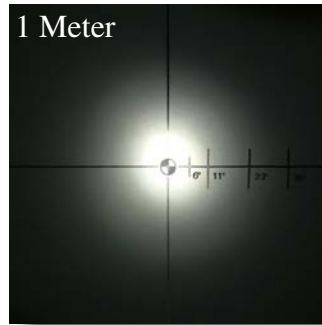

KCLP20CR

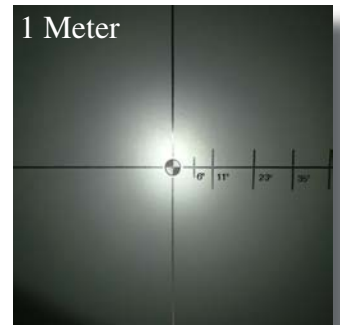

KCLP20ST

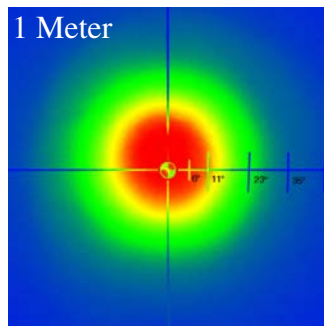

KCLP17CR
Spectro Metric Analysis

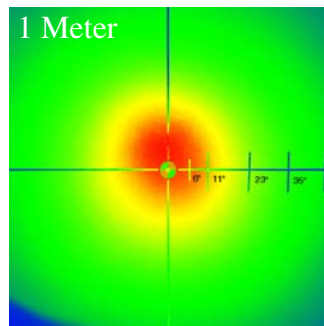

KCLP17ST
Spectro Metric Analysis

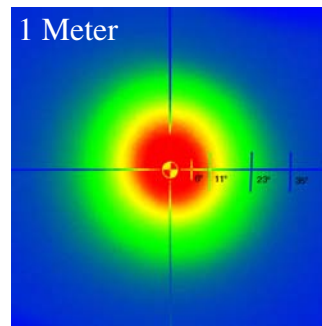

KCLP20CR
Spectro Metric Analysis

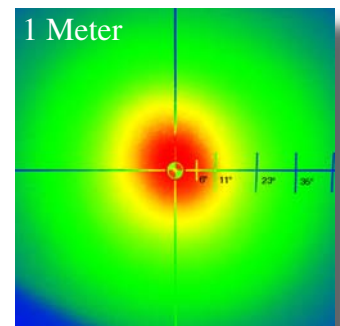

KCLP20ST
Spectro Metric Analysis

Measurements carried out with Luxometer mod LUX-1337. Room Luminous Intensity: 0 Lumen. Camera mod. Fujifilm S7000

Ordering part number:

KCLP XX XX

CR = metalized (Narrow beam)

ST = embossed surface (Medium beam)

17 = Ø 17,5 mm

20 = Ø 20,5 mm

Drawing.

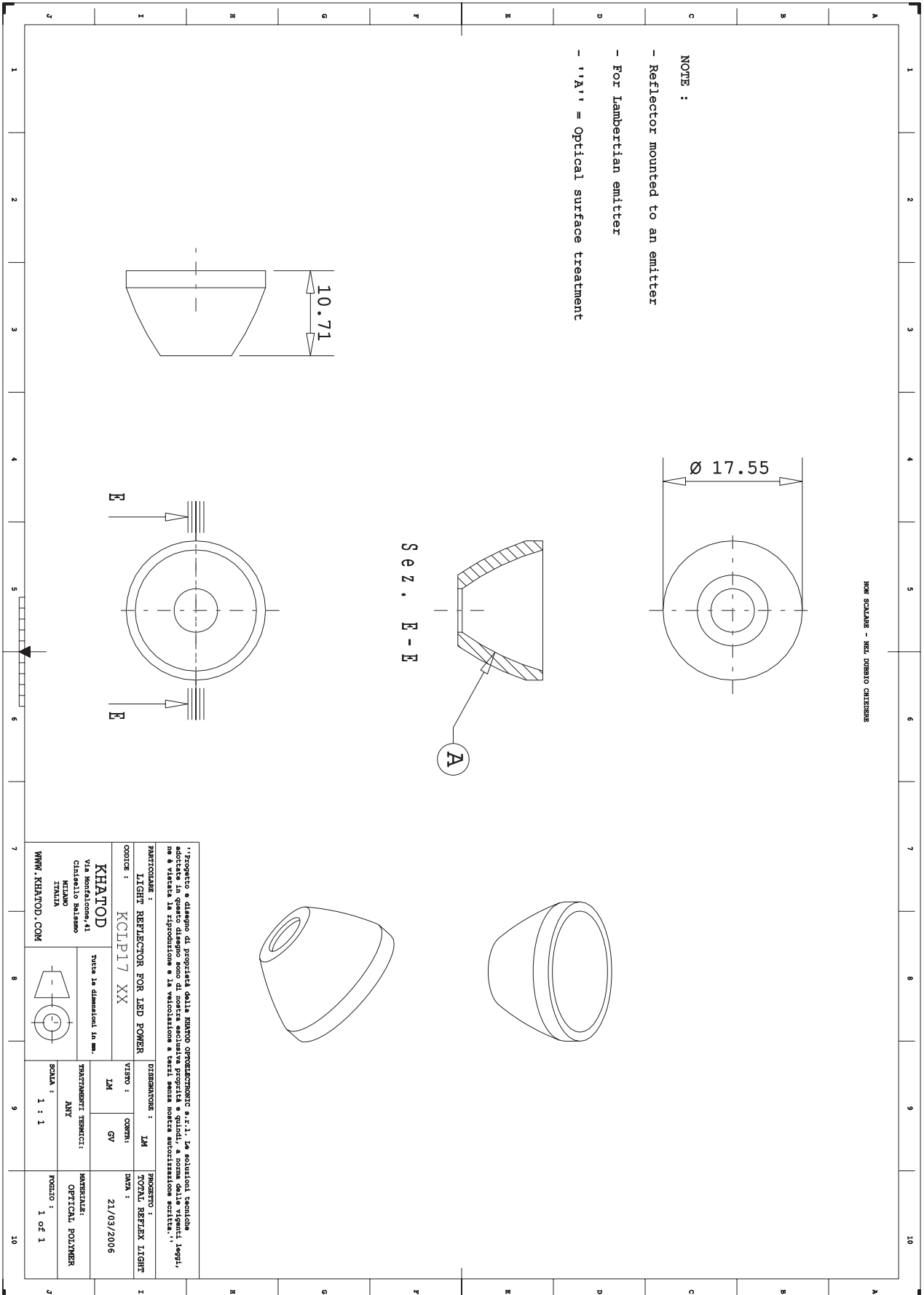

Drawing.

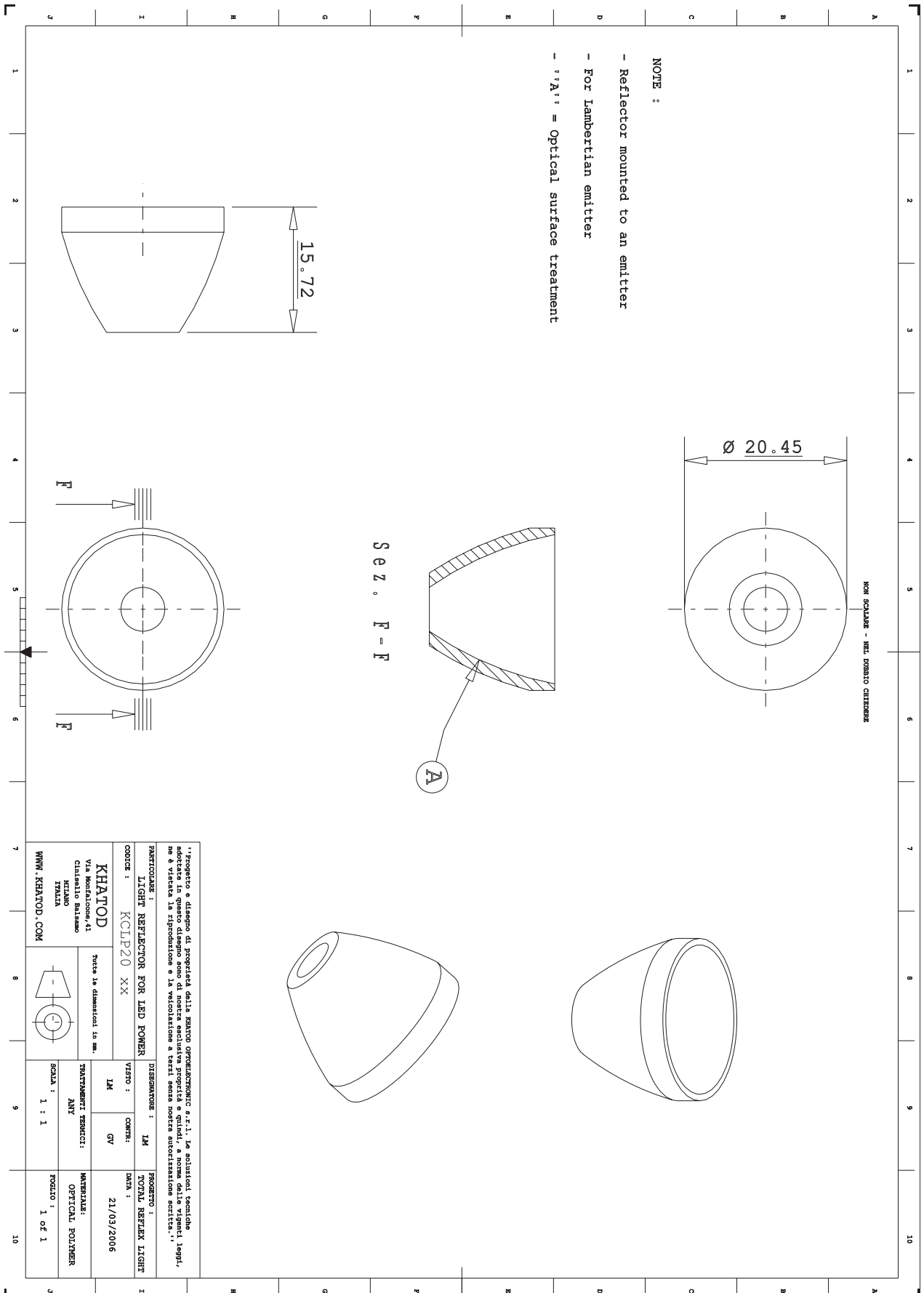

Reflectors characteristics

Parameter	Symbol	Rating	Unit
Reflector Material	PC Polycarbonate, Aluminium reflective coating with protective clear-coat	--	--
Operating Temperature	Topr	-40 to +120	°C
Storage Temperature	Tstg	-40 to +120	°C

Published by Khatod optoelectronic srl - All the data contained in this documents are the property of Khatod optoelectronic srl and may change without notice.

Notes:

Please note that small defects in the reflective coating, flow lines and weld lines on the surfaces of the reflectors are acceptable if the optical performance of the reflectors is within the specification described in the section "OPTICAL CHARACTERISTICS"

- Should you require further information, please contact Khatod for advice.
- All reflectors testing must be subject to identical conditions as Khatod test condition.

KHATOD REFLECTORS Use And Maintenance

- DO NOT HANDLE OR INSTALL REFLECTORS WITHOUT WEARING GLOVES, SKIN OILS MAY DAMAGE LENS OR LIGHT TRANSMISSION
- CLEAN LENSES WITH MILD SOAP AND WATER AND A SOFT CLOTH
- DO NOT USE ANY COMMERCIAL CLEANING SOLVENTS ON REFLECTORS

Khatod SRL, Milan, Italy, manufactures lenses for LEDs. Any other use of the lens shall void our liability and warranty. The lenses are an inert component to be used in the manufacture of various products. Our warranty and liability are limited only to the manufacture of the lens. You may not modify, copy, distribute reproduce, license or alter the lens and related materials of Khatod SRL. Khatod SRL does not warrant against damages or defects arising out of the use or misuse of the products; against defects or damage arising from improper installation, or against defects in the product or in its components. No warranty of any kind, expressed or implied, is made regarding the safety of the products. The entire risk as to the quality or performance of the product is with the buyer. In no event shall Khatod SRL or Khatod USA be liable for any direct, indirect, punitive, incidental, special, consequential damages, or any damages whatsoever arising out of or connected with the use or misuse of the product. Khatod SRL shall not have any obligation with respect to the product or any part thereof, whether based on contract, tort, strict liability or otherwise. Buyer assumes all risks and liability from use of the product. The laws of Milan, Italy govern this product warranty and liability and you hereby consent to the exclusive jurisdiction and venue of courts in Milan, Italy in all disputes arising out of or relating to the use of this product.